

AirflexPro

ZERO LEAKAGE SEMI RIGID DUCTING



RESIDENTIAL FANS



HEAT RECOVERY



COMMERCIAL FANS



DUCTING ACCESSORIES



MORE THAN 60 YEARS OF EXPERIENCE

Founded in 1955, Airflow has grown from one man's expertise in fan design and air flow measurement into a thriving international group. Renowned for its innovative approach to new product development and air movement techniques, Airflow can offer you a variety of ventilation solutions to meet new and increasing customer demands and regulatory needs.

With our headquarters in High Wycombe, Airflow has subsidiaries in Germany and the Czech Republic and has global distributors from Norway to New Zealand.

Listening to the requirements of our customer enables Airflow's knowledgeable and committed staff to continually develop new and innovative products that raise standards and provide long term, reliable ventilation solutions.



UNITED KINGDOM

High Wycombe (Head Office)

Our founder started the business in 1955, just one mile from the current site, which has been Airflow's headquarters since 1960, co-ordinating our global activities.



GERMANY

Airflow has been serving ventilation products and air measurement devices to the German and European markets for over 50 years. Operating near Cologne, Airflow Germany has their own customer service, sales and technical sales teams.



CZECH REPUBLIC

Founded in Prague over 20 years ago, the Airflow Czech Republic team offer sales and servicing of ventilation products for the Eastern European market.



FRESH AIR - AN ELEMENT OF LIFE



THE PROBLEM

New Build dwellings, Carbon neutral and Passive houses have greater insulation and air tightness, but poor indoor air quality can potentially lead to condensation, mould growth and respiratory health issues.

In fact, the detrimental issues caused by Toxic Home Syndrome are now fully established with ample evidence available to prove that the health and wellbeing for millions of people can be affected by the poor air quality present in their homes. A lack of adequate ventilation to disperse and remove airborne indoor toxins and Volatile Organic Compounds (VOCs) is at its core, while the structure of a building can also suffer from the failure to remove damp moist air, causing mould and potential structural damage.

With an increased fabric first approach towards delivering higher insulation levels for new homes as well as older properties, renovations and upgrades, the need to provide an efficient, yet cost-effective ventilation solution to these almost airtight homes becomes more imperative.



THE SOLUTION

The design of an effective, continuous operation and low energy ventilation system can help improve the indoor environment while protecting the fabric of the building and improving occupant wellbeing.

AIRFLEXPRO – MOVING AIR EFFICIENTLY AND EFFECTIVELY

AirflexPro is an air ducting system, when used in conjunction with a Mechanical Heat Recovery Unit (MVHR) it provides a total ventilation system for dwellings. When combined with commercial MVHR and MultiPlexBox it can be used to give zonal control in offices and apartments. AirflexPro is a radial ducting system offering advantages over the more traditional branch systems. AirflexPro is suited to new build but can also be used in the retrofit market and can be combined with such technologies as coanda valves. The system has zero leakage and low system pressure, therefore making it a very efficient air movement system.



ENERGY SAVING



TRADITIONAL DUCTING = ENERGY LOSS

An efficient MVHR unit is only as good as its air distribution system. Traditional duct systems have numerous joints all of which are prone to leakage. Leaking duct systems are inefficient and waste energy, as a proportion of the air never reaches its destination.

Flexible and rigid branch systems can result in restricted airflows and higher system resistances. They can also transmit sound throughout the ducting causing unwanted and nuisance noise in other rooms.

Poor duct installation also costs money. Overcoming a leaky duct system means the MVHR unit will have to run at a higher speed to give the required airflow rates in the correct areas of the property. Badly designed duct systems, or systems that do not follow the designed route, will have higher system pressures. In extreme cases an MVHR unit sized correctly for a dwelling will not be able to cope with the extra demand created by the additional pressures. AirflexPro is a highly flexible, efficient and easy to install ducting system which eliminates these problems.

AIRFLEXPRO = ENERGY SAVING

It makes no sense to invest in an energy efficient MVHR unit to improve wellbeing and indoor air quality when the energy saving benefits to be gained are lost through leakage from traditional branch ducting systems.

FEATURES

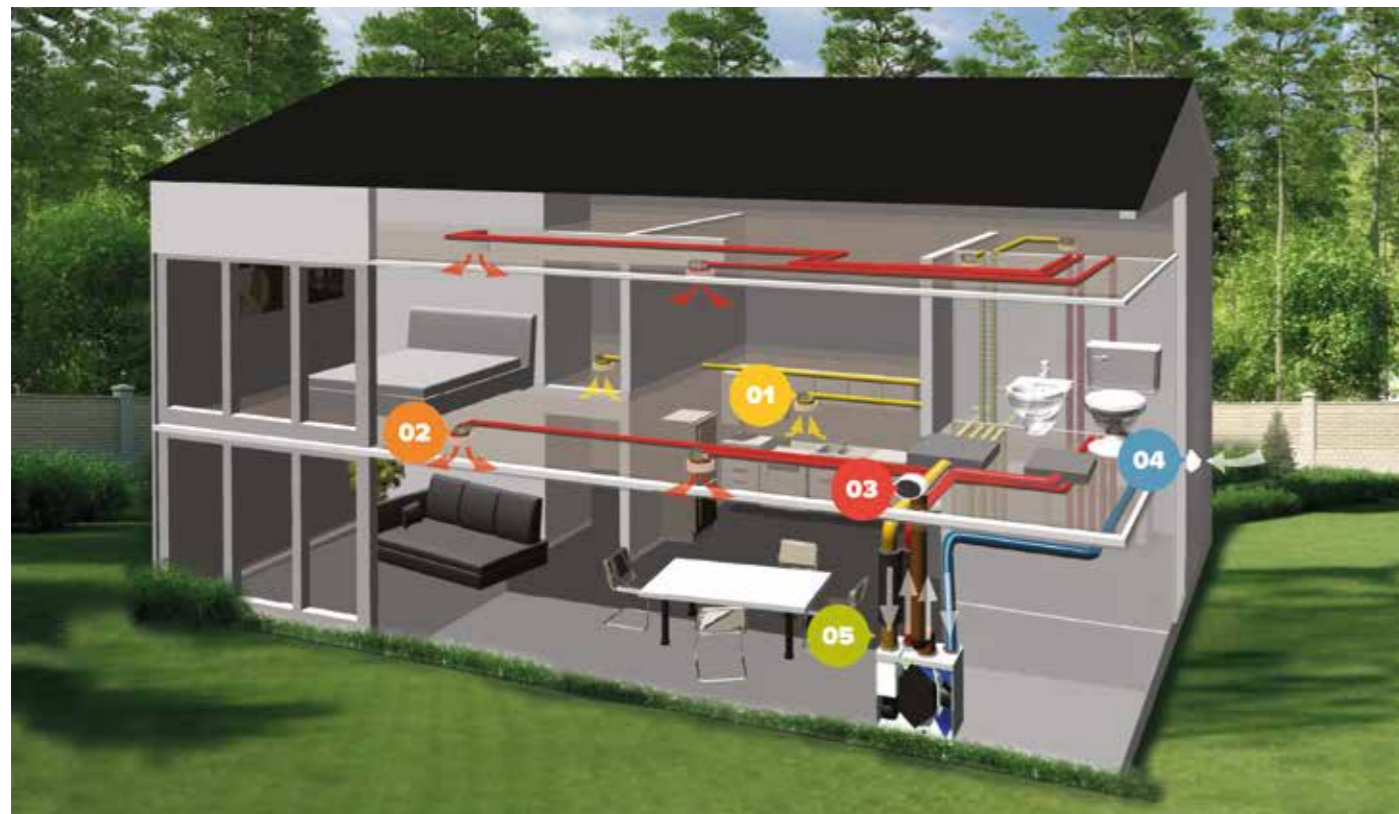

SEMI RIGID DUCTING ADAPTABLE AND UNIQUE



A quick and easy to fit system of semi-rigid ducting that can result in up to 70% time saving during the onsite installation process compared to traditional rigid or spiral duct methods.

This innovative system uses low resistance, smooth bore, antibacterial round and elliptical tubes which connect to each room from the MVHR unit via a distribution box.

The AirflexPro elliptical pipe is designed with equal hydraulic performance to AirflexPro round pipe and is totally

interchangeable, so both types of ducting can be planned into the same system with no loss of performance.

The system has been tested by the independent Building Research Establishment (BRE) and is listed on their Standard Assessment Procedure (SAP) Appendix Q product compendium.

KEY FEATURES

- Quick to plan and easy to fit semi rigid ducting system.
- Saves up to 70% installation time on site.
- Lightweight, tough, durable and conveniently supplied in rolls (50m AirflexPro round & 20m AirflexPro elliptical).
- Requires minimum space, easily fitted through narrow joists, I beams, suspended ceilings, cavity walls and under floor.
- Unique crushability up to 10 kN/m², so duct can be run in screeds or inbedded in concrete for a permanent non degrading installation.
- Anti-static inner coating prohibits dust from collecting within the tube.
- Antibacterial lining improves hygienic conditions.
- Low resistance, air safe smooth bore lining delivers low system pressure enabling longer duct runs without increased air noise.
- Logical, easy to use planning software to produce a comprehensive MVHR system design.
- Compatible with all Airflow MVHR air handling units.
- Consistent hydraulic performance for round and elliptical ducting.

AIRFLEXPRO - ROUND AND ELLIPTICAL

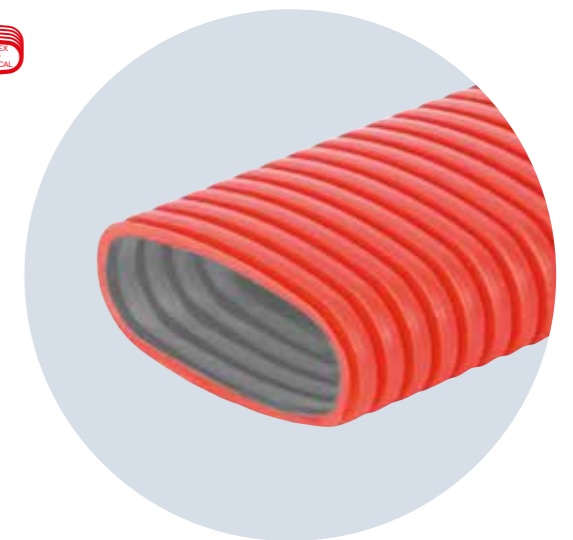
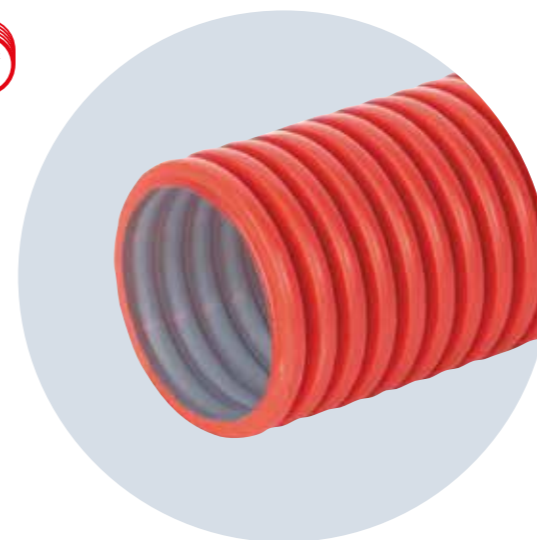

AIRFLEXPRO LINING

- Anti-static - prevents dust build up.
- Antibacterial - improves hygienic conditions.
- Smooth - ensures low air noise.
- Smooth - ensures low system pressure.

Unlike a conventional branched air ducting system AirflexPro offers much broader functionality.

AirflexPro can be hidden behind suspended ceilings or embedded into walls and floors.

In addition to the ease of installation the system offers significant savings in time and money on-site.



COMPACT PROFILE

The system is suited to custom ceiling configurations. With its low profile it is ideally suited to narrow ceiling joists, I beams, wall and underfloor installation.



WORKS UNDER PRESSURE

The material and shape of the semi-rigid ducts help them sustain high external loads, such as the pressure produced by cement, by having a semi rigid, polymer tough ribbed outer pipe. This means that despite external pressure your pipe will continue to deliver air to each individual room as needed.



IMPROVED INTERIOR AESTHETICS

AirflexPro is hidden in or under floors, ceilings or walls. The only visible parts are the stylish grilles and valves.



LOW NOISE LEVELS

Produces less noise pollution than traditional ducting methods due to the smooth bore inner lining of the duct and lower system pressure.



COMPATIBLE

All AirflexPro duct products are interchangeable with each other.



NO AIR LEAKAGES

100% zero leakage as all connections have a neoprene sealing ring.



QUICK AND SIMPLE ASSEMBLY

Thanks to the flexible properties of the duct and multifunctional fittings no special tools are required. With radial duct installation originating from a central distribution box and on a roll, it saves installation time and ensures straight forward commissioning.



MAINTENANCE

Access doors on distribution boxes and smooth lining of the duct help facilitate regular maintenance.



FIRE RATED TO DIN STANDARDS

Meeting requirements of DIN 4102-4 and EN 13501-1.

UNIQUELY CONNECTED



MIX AND MATCH ROUND AND ELLIPTICAL PIPE WITH NO LOSS IN PERFORMANCE

AirflexPro is the only semi rigid duct system that can interconnect through a single transition component from round to elliptical and vice versa, without any gain in system pressure.

- Why compromise with an inferior system when you can have the flexibility and performance of the AirflexPro range?
- AirflexPro can offer you flexibility and versatility to suit your installation needs.
- Both round and elliptical pipes have been designed to have the same hydraulic performance ensuring no disruption in flow rate when connected together.

DUCTING CLIPS

AirflexPro round and elliptical clips are the only professional solution for fitting SAP eligible, Zero Leakage duct systems. These compact ducting clips have been specifically designed for narrow or confined areas to keep ducting off the building fabric to reduce noise transmission and thermal bridging. By positioning the clips at 750 mm intervals, it will secure the ducting in a tidy manner and will be in accordance with NHBC guidance 3.2.

HYDRAULIC PROFILE AND PERFORMANCE - WHAT DOES IT MEAN?

The hydraulic profile and performance of a duct is dependent on its internal cross section. This is the empty space in a circular or elliptical duct cross section that affects the flow of air within the duct. The inner cross sectional area of AirflexPro round and elliptical are the same. This unique design achieves the same hydraulic performance for both round and elliptical.

Therefore, you can switch from round to elliptical using transition pieces in the duct layout to enable optimum efficiency when routing ducts in confined spaces.

No other duct system has this technically interchangeable round to elliptical design.

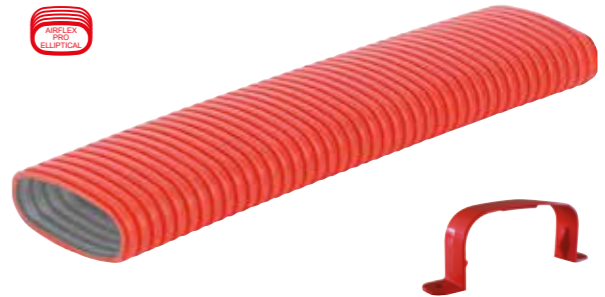

The interchangeable combination of AirflexPro round and elliptical ducting results in a truly unique air duct system which can be used with MVHR units to produce a zero leakage system.

By using AirflexPro the required airflow rates to each room can be easily obtained. By using 1 or 2 ducts for each supply and extract point you will optimize the low airflow velocity which reduces noise.

High velocity = high noise
Low velocity = low noise

System designers and planners will appreciate the flexibility of the duct pipe and its choice of compatible connection components which have identical air movement properties.

The option of using either a round or elliptical pipe means the most suitable duct routing in any plane provides the ability to by-pass structural obstacles in walls, ceiling voids and under the floor.

Duct joints have been engineered to give a leak free, easy to assemble system. The use of a high quality neoprene seal and two holding clips on each joint, prevents leakage and lateral movement, ensuring the systems joint integrity.

Rolls of ducting and end of duct components are supplied with blanking caps. Using these blanking caps stops the ingress of building work contaminants after the system has been installed.

Polypropylene AirflexPro ceiling and wall plenums, display easy to identify mounting height markers on the surface of the product. This ensures you can get a uniform cut length for each plenum everytime, engraved key marks on distribution boxes ensure alignment with duct connections.

At the project planning stage AirflexPro software guides you through the steps required to create the most efficient duct layout with the AirflexPro product range.

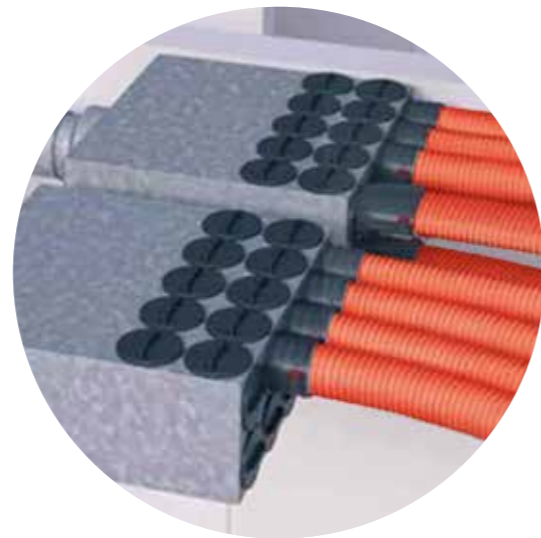

RECOMMENDED BY ALL



“ The installation went according to plan and the whole system is working very well... Thanks for your excellent service! ”

Quantity Surveyor



“ As a contractor working throughout the UK installing residential HVAC equipment in new and refurbishment houses I have no hesitation in recommending AirflexPro for the ventilation ducting systems.

The quality of material is second to none and the flexibility of ducting made it possible to install very quickly even in narrow spaces. ”

Director from installation company



“ I am very pleased with your semi-rigid ducting which I've begun using immediately. I am particularly impressed with its ability to quickly fit to each component, and also its leak-proof design thanks to the easy-to-fit sealing rings. The AirflexPro ducting has already paid for itself in time saved! ”

Design Architect



“ Specification of AirflexPro has added value and raised the standard of the ventilation system throughout the dwelling, while contributing to a lower carbon environment for the homeowner. ”

Project Manager



BRANCH VERSUS RADIAL

LOW PRESSURE = LOW ENERGY
= QUIET PERFORMANCE

AirflexPro ducting offers you the same airflow but with much reduced system pressures in comparison to conventional rigid and flexible ducting. This results in a much more energy efficient, quieter system where fan speeds can be reduced.

Air Velocity M / s	Air Volume M ³	Resistance Pa / Mtr
0.5	6	0
1	11	0.5
1.5	17	0.8
2	22	1.5
2.5	28	2.2
2.7	30	3

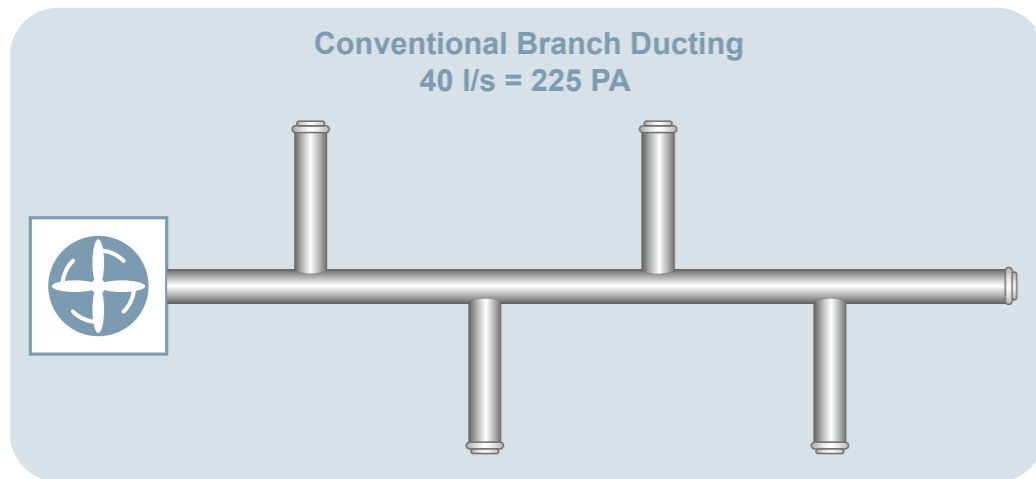

VERSUS

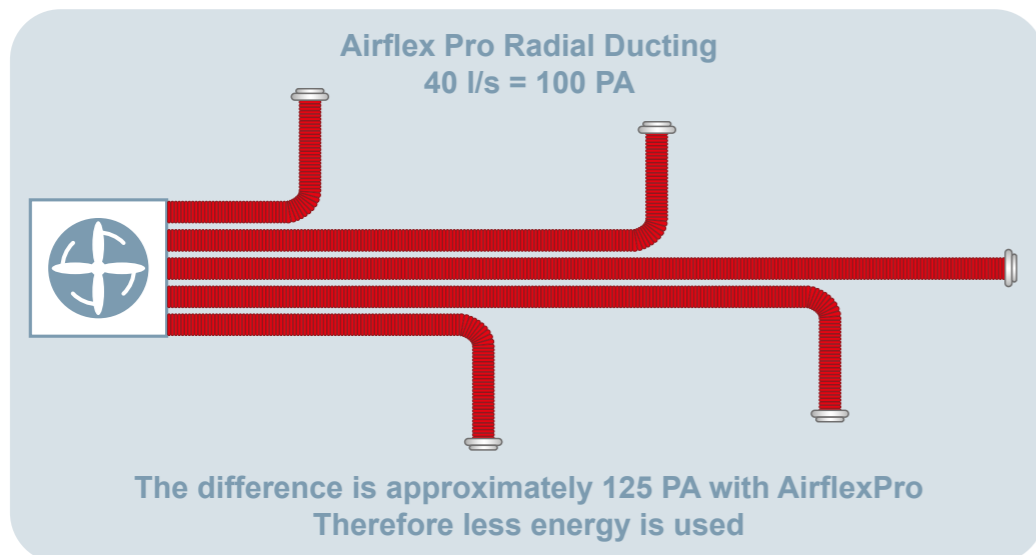

AirflexPro system pressure graph

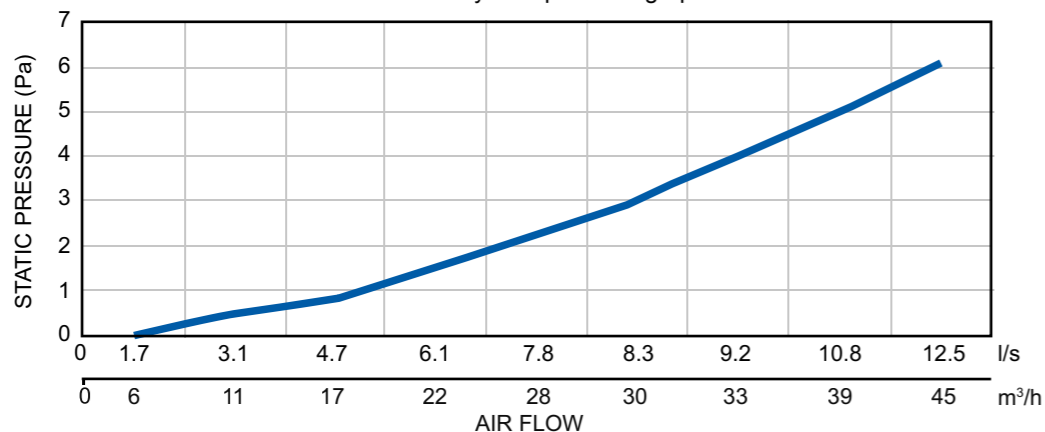

DURABILITY AND FLAMMABILITY

TOUGH STUFF

AirflexPro round and elliptical ducting is conveniently supplied in lightweight coils (round 50 m / elliptical 20 m) for ease of transport and manoeuvrability on site through narrow gaps and voids.

AirflexPro Ducting has an outer ribbed skin made of PE-HD (Polyethylene - High Density) which is a thermo plastic material. This is known for its high strength to density ratio and anti-corrosion properties. Its German engineered design gives it extreme flexibility and strength. With a bend radius as small as 150 mm diameter (see Figures 1 & 2 below) and an excellent crushability of up to 10 kN/m², the installation options are almost limitless.

The outer tough skin is teamed up with a PE-LD (Polyethylene - Low Density) smooth, highly efficient internal duct. The

properties of this smooth duct have been chosen especially for ventilation applications. This PE-LD material incorporates anti-bacterial, food grade and anti-static properties.

PE-HD and PE-LD have been long established materials used for plastic bottles and water pipes. In addition, these materials are 100% recyclable.

AirflexPro round and elliptical semi rigid ducting performance data is recognised by the U.K Government as an input for the Standard Assessment Procedure (SAP) calculation. AirflexPro ducting is registered on the Product Characteristic Database (PCDB) as an energy saving system.

Figures 1, 2 and 3 below demonstrate the flexibility of this range of product.

AIRFLEXPRO SEMI RIGID DUCT FLEXIBILITY

The Domestic Ventilation Compliance Guide describes that the inner radius of any bend should be greater or equal to the diameter of the ducting being used. If the radius is reduced, the resistance of the bend will increase, and the volume of air being extracted will decrease.

AirflexPro Ducting's inner radius for 90° bends will always be greater than (not just equal to) the diameter of the AirflexPro Ducting. (2x or 3x diameter of the AirflexPro Ducting)

Figure 1. 90° bend

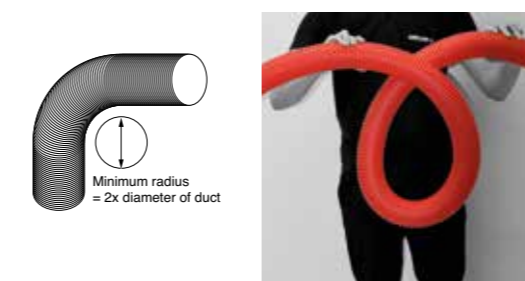

Figure 1: Round AirflexPro Ducting is used in both images. First image is showing a 90° bend which will have the inner radius of minimum 2x diameter of the round duct.

The second image is showing an example, that even if the installer were to create a loop, the AirflexPro inner radius will still remain within the same dimensional parameter due to its material properties.

Figure 2. 90° Lateral bend

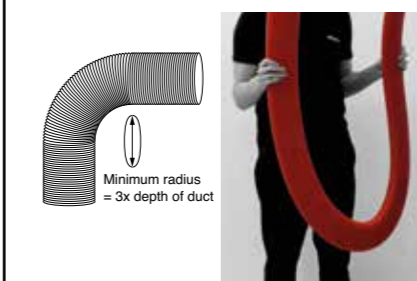

Figure 2: Elliptical AirflexPro ducting is used for both images. First image is showing a 90° bend which will have the inner radius of minimum 3x diameter of the elliptical duct.

The second image is showing an example of a U shape bend where the AirflexPro inner radius will still remain equal or greater than 3x diameter of the elliptical duct.

Figure 3. 90° Horizontal bend

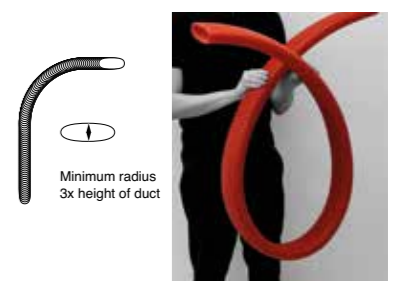

Figure 3: Elliptical AirflexPro ducting is used for both images. The first image is showing a 90° bend which will have the inner radius of minimum 3 x diameter of the elliptical duct (this is the same dimensional parameter as the previous image but from a different view side).

The second image is showing an example, that even if the installer were to create a loop, the AirflexPro inner radius will remain within the same dimensional parameter due to its material properties.

FIRE RESISTANT

AirflexPro has been tested for its flammability properties and is widely installed in residential dwellings throughout Europe. AirflexPro pipe has been tested according to robust fire safety procedures. Following the latest German engineering and European standards, we aim to keep you feeling secure and content with your product. AirflexPro pipe and associated fittings achieve the following fire safety ratings:

- European EN 13501-1 - Fire classification of construction products and building elements. Part 1: Classification gained using data from reaction to fire tests, achieving a Class E rating.

Always consult the latest Building Regulations, Approved Document B and other relevant documents to confirm this fire rating is acceptable for your project.

- DIN 4102-4 - Fire behaviour in relation to building materials and components achieving a building material class B2.

HOW TO CONNECT YOUR SYSTEM



HOW TO PROPERLY CONNECT YOUR AIRFLEXPRO PIPES:

- **Step 1:** Cut your pipe to the desired length, the material can easily be cut with a boxknife or similar.
- **Step 2:** Slide the neoprene sealing ring over the pipe. It must be the correct sealing ring (round sealing ring or elliptical sealing ring).
- **Step 3:** Make sure the sealing ring is located on the second indent.

Important: The sealing ring is essential for maintaining air tightness, without it your system will not perform correctly.

THE RIGHT WAY



THE WRONG WAY



CONNECTING TO YOUR PLENUM

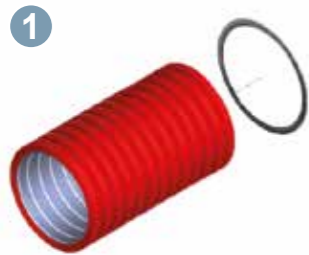

A sealing ring must be fitted in the second complete indent of AirflexPro.



Slide the duct into the fixture so the seal goes past the clip slots.

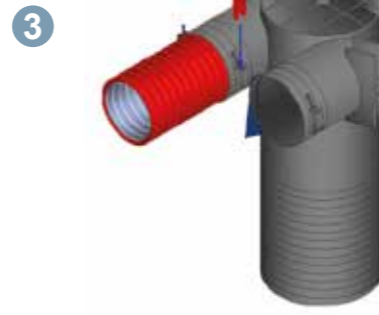

Fit the two retaining clips to hold the AirflexPro in place.

USING ROUND STRAIGHT CONNECTION PIECES

Connecting your round pipe together is easy with the straight connector.

- **Step 1:** Make sure your sealing ring is attached correctly on the second indent of the duct.
- **Step 2:** Inside the connector at each end are two duct retaining lugs. Align the duct, with seal in position, ready to insert into the connector.
- **Step 3:** Push the duct into the connector, so the seal passes the lugs, stopping before the centre groove.

Important: If your design requires the ducting to be laid in concrete, do not allow concrete to penetrate the connection piece. Use tape around the outside of the connector if necessary.



USING AIRFLEXPRO CONNECTION PIECES

Connect elliptical and elliptical to round pipe together using AirflexPro fittings. The robust side mounting feet enable secure fixing of the connection piece to mounting surfaces.

- **Step 1:** Remove all fixing clips. Ensure the sealing ring is positioned correctly on the duct. Align duct to the connector.
- **Step 2:** Push the pipe into the connector until it reaches the internal stops.
- **Step 3:** Ensure the duct indent is aligned with the duct clip holes. Push all retaining clips into the connector to hold the ducting in place.

Important: If your design requires the ducting to be laid in concrete, do not allow concrete to penetrate the connection piece. Use tape around the outside of the connector if necessary.



CONNECTING A 90° COMPACT ELBOW

AirflexPro round, compact 90 degree elbow, should be used where the minimum bend radius of the duct is not small enough (see page 19).

- **Step 1:** Make sure your sealing ring is attached correctly on the second indent of the duct.
- **Step 2:** Push duct into the fitting making sure the seal has gone past the two duct securing tabs (one either side).
- **Step 3:** Ensure the duct indent is aligned with both duct securing tabs.
- **Step 4:** With a small blunt tool press the securing tab into indent of the duct.

Please Note: When pressing the securing tabs do not pierce the duct.



CONNECTING YOUR PIPE TO A DISTRIBUTION BOX

The AirflexPro system comes with various sized distribution boxes. These boxes offer flexible ways to connect AirflexPro round and elliptical duct. The connectors follow the same principle of connecting as the previous AirflexPro fittings.

Follow these steps:

- **Step 1:** Remove the clips.
- **Step 2:** Insert the round or elliptical pipe, depending on your connector, into the port. Ensuring the sealing ring is in the correct position, second indent.
- **Step 3:** Push the pipe into the connector until it reaches the internal stops. Push all retaining clips into the connector to hold the ducting in place.



AIRTIGHT FIT

To seal off redundant round or elliptical duct connectors use the relative blanking cap (as supplied) and seal.

- **Step 1:** Position the relevant seal correctly in the first full groove of the blanking cap. See page 12, reference "HOW TO PROPERLY CONNECT YOUR AIRFLEXPRO PIPES"
- **Step 2:** Remove any red retaining clips that are positioned in the duct connector.

- **Step 3:** Press blanking cap, with seal in position, into duct connector until it stops. Next fully insert the two red retaining clips in to the duct connector to lock the blanking plug in place. An audible click can be heard when the red clips are fully inserted.



LOCKING MECHANISM EXPLAINED

When connecting AirflexPro to metal fittings, use the plastic bayonet type connectors provided. All bayonet fittings are marked with open and closed padlock symbols at their joint end.

- **Step 1:** Offer up the plastic bayonet connector to the port on the metal fitting you want to attach to. Then align the open padlock symbol on the plastic connector to the indent arrow on the metal fitting. The bayonet arms of the connector should now align with the cut out on the metal fitting.

- **Step 2:** Firmly press the connector into the metal fitting.
- **Step 3:** Turn the connector clockwise until the closed padlock symbol aligns with the indent arrow on the metal fitting.
- **Step 4:** Now your connection is locked in position and its joint is airtight.

Please Note: Should you wish to remove connections or blanking caps - simply reverse this procedure.

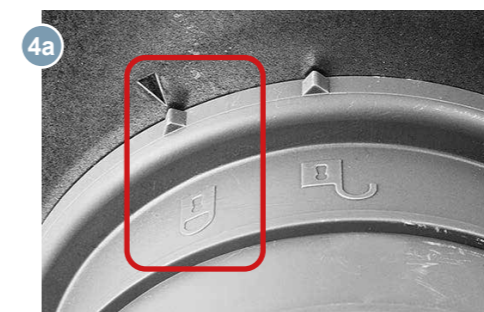
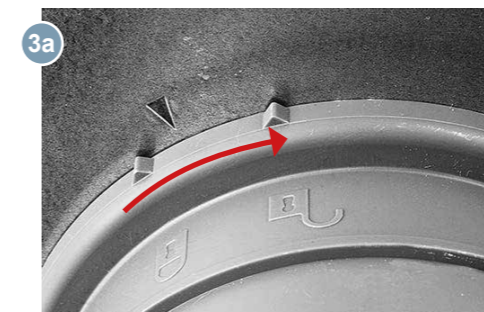
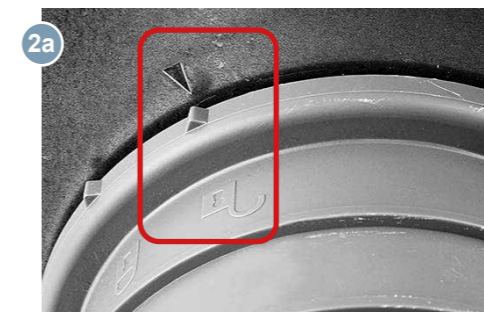
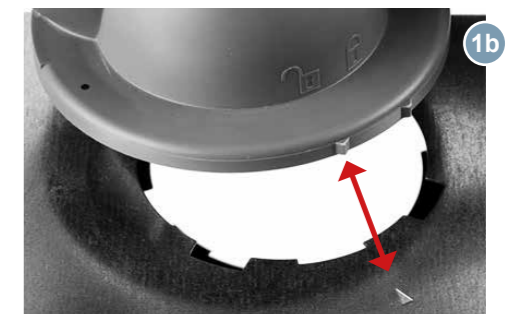
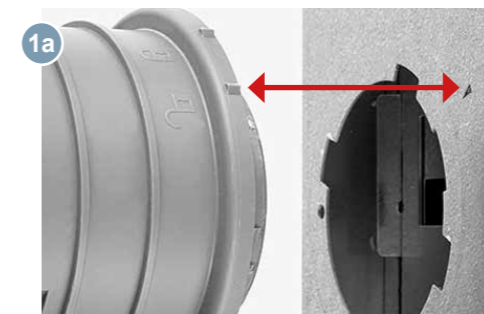

PLENUMS



FOR WALL, CEILING AND FLOOR APPLICATION



CUSTOM SIZING

Each plenum box comes with clear height indicators, allowing you to precisely cut the product down to your required recess depths.

ROBUST

The plenum box is made from impact resistant polypropylene, giving solid floor mounting stability and the ability to be cast in concrete.

EASY FITTING

Incorporating robust mounting feet makes for fixing and box adjustment.

UNIQUE

Features two AirflexPro zero leakage duct connections complete with its unique duct locking mechanism. Each connection suitable for up to 30 m³/h (8.3 l/s).

MOUNTING & COMMISSIONING

Suitable for floor, wall or ceiling mounting. Each box has an easy to adjust, lockable, air volume regulator for ease of commissioning.

DESIGNER GRILLES

Three different wall grilles available (Squared, Wavy and Slotted) in brushed stainless steel or powder coated signal white. With elegance and style, these are suitable for any room décor and provide noise free ventilation airflow.

GRILLE LEVELLING FRAME

Each grille is supplied with a simple to use levelling frame, enabling flush or surface mounting of the grille.



PLENUMS



DIMENSIONS

AirflexPro ceiling / wall plenum are supplied with two spigots suitable for either round or elliptical ducting which connect at right angles to the 125 mm inside diameter valve connection. The overall lengths of the plenums 125 mm diameter connection is 328 mm for the round and 300 mm for the elliptical. This connection can be cut to length, if needed, to suite individual installations. A cutting guide to valve part number is below.

Please note. When the plenum is installed, the 125 mm diameter connection tube should finish flush with the ceiling / wall - NOT BELOW.

AIRFLEXPRO ROUND PLENUM

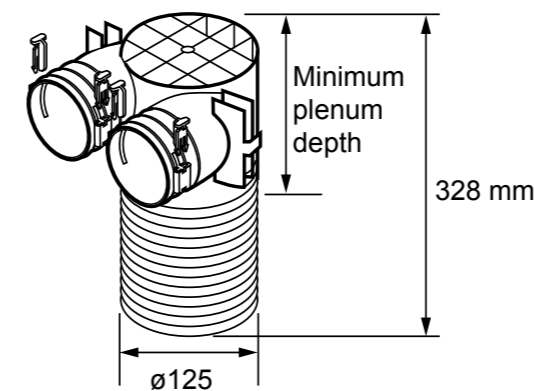

AIRFLEXPRO ELLIPTICAL PLENUM

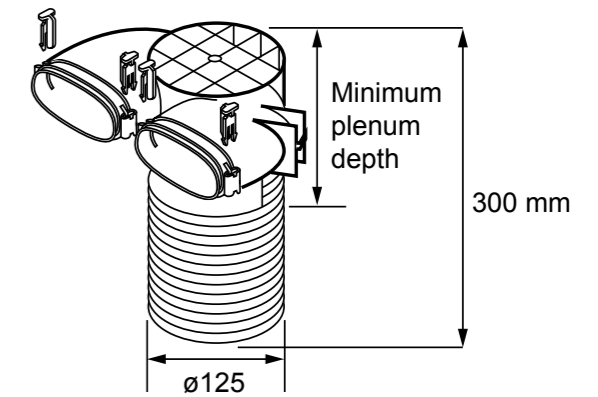

Supply Valves		
Valve part number	Min plenum depth (round plenum)	Min plenum depth (elliptical plenum)
90000339	85 mm*	70 mm*
9041166	100 mm	100 mm
9041168	85 mm*	70 mm*

Extract Valves		
Valve part number	Min plenum depth (round plenum)	Min plenum depth (elliptical plenum)
90000340	85 mm*	70 mm*
9041172	85 mm*	70 mm*

Supply & Extract Valves		
Valve part number	Min plenum depth (round plenum)	Min plenum depth (elliptical plenum)
90000126	105 mm*	70 mm*
90000316	100 mm	100 mm

*Need to remove threaded support in plenum.

DISTRIBUTION BOXES FOR SYSTEM FLEXIBILITY

AirflexPro distribution boxes are the primary component in the quiet, effective distribution of supply and extract air, to and from the central MVHR unit.

They can be configured for in-line, 90 degree angle and side on connection so that they integrate into any building layout enabling smooth easy access to connect to round and elliptical ducting.

Available from 5 to 15 duct connection ports, depending on the system design and for full flexibility, it is supplied with fixing

brackets and screws. They are fully insulated to retain warm air energy and acoustically lined to absorb airbourne noise. Unused ports should be sealed with blanking caps.

Constructed from durable steel they are tough for on-site handling and incorporate an access door enabling routine internal cleaning and maintenance. Each connection port has a key way indicator mark to easily align round and elliptical duct connectors during the installation process.

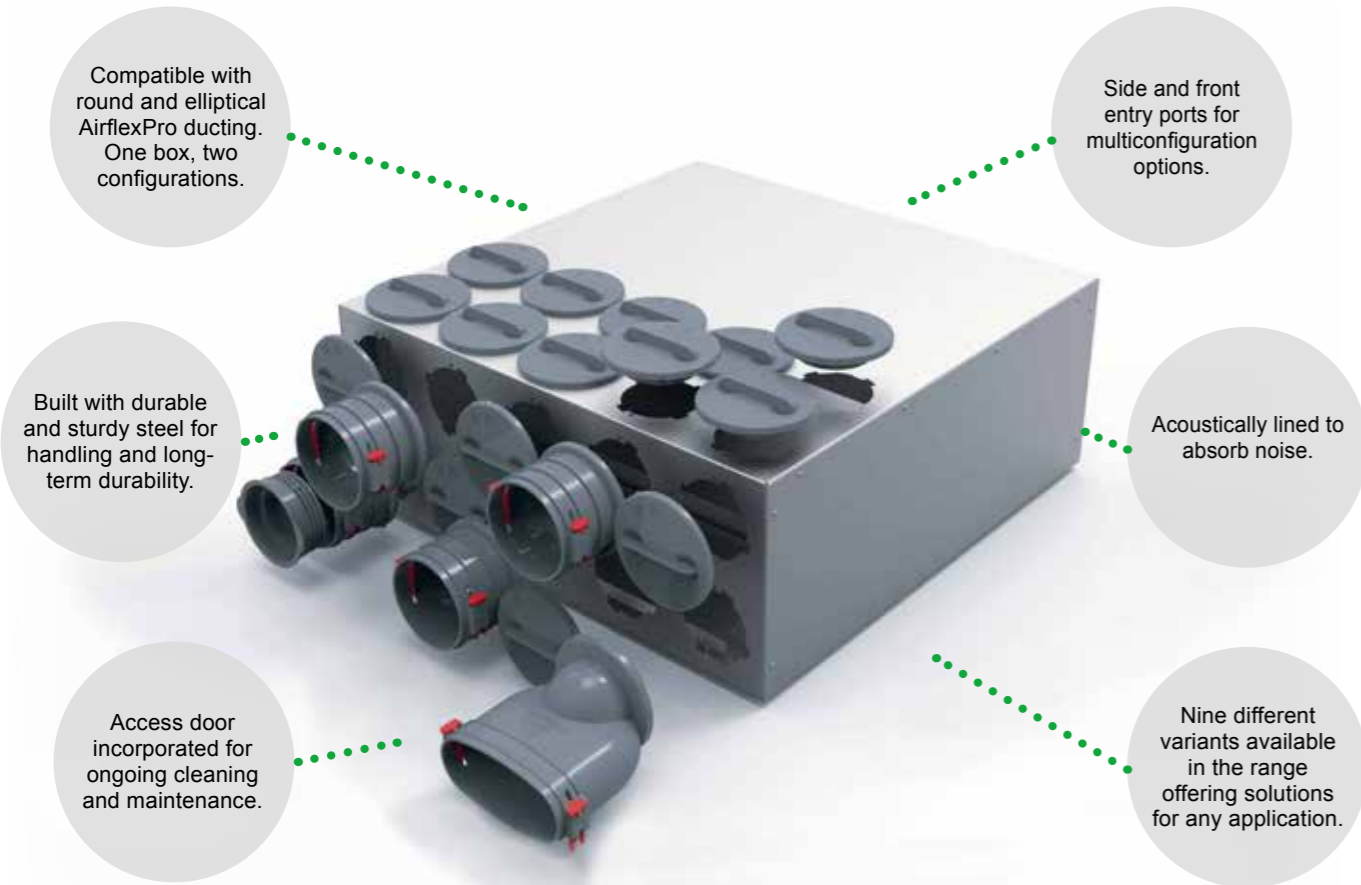

DISTRIBUTION BOXES

5 PORT DISTRIBUTION BOX

Airflow's most popular distribution box, offering exceptional versatility and ease of fitting, even in extremely restricted applications. Designed specifically for 90 degree installation, there are four duct connection port options on the front with a further two side entry ports, one on each end of the box. This enables the box to be located in situations where ducts converge from many different directions. Plenum boxes can be used in any orientation.

Any configuration of up to 5 supply or extract ducts may be connected. Use round or elliptical pipe or a combination of both through transition pieces. Blanking caps are supplied to seal unused ports.

In addition this box offers two choices of entry for the 125 mm diameter primary air connection to the central MVHR unit. The standard off-set end case connection can be changed to the front face of the distribution box casing, allowing easier pipe routing within the buildings constraints. Mounting brackets and blanking caps to secure the air tightness of the unused port are supplied with the box.

This version is also especially suitable for integration in suspended ceiling voids and attaching to concrete beams for running multiple direction ducts.



APPLICATION EXAMPLES

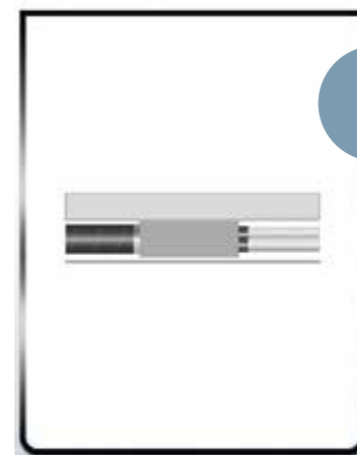

Example 1: Placing a distribution box under the floor.



Example 2: Placing the distribution box at a right angle.

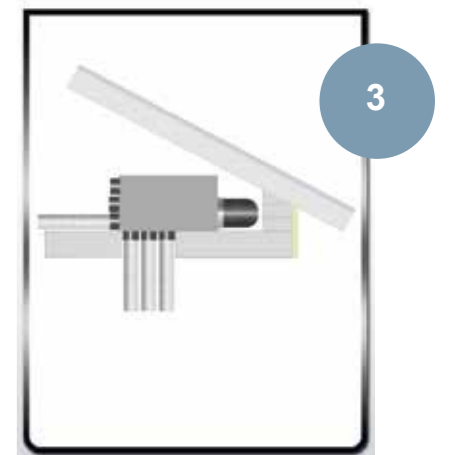

Example 3: Placing the distribution box in a warm loft space.



6 PORT DISTRIBUTION BOX

With a unit depth of only 160 mm this durable distribution box works well in tight spaces. Features in-line connections of (125 mm dia) to the MVHR unit for up to 6 supply or 6 extract ducts. You cannot use round and elliptical on 1 distribution box*.

Choose either the round or elliptical distribution box depending on what model of pipe you are connecting. Mounting brackets and blanking caps are supplied to seal unused ports. Ideal for narrow joist applications.

* without losing use of some ports

15 PORT DISTRIBUTION BOX

Our biggest distribution box for larger MVHR systems with 30 duct connection options either in-line or at 90 degrees. Any configuration of up to 15 supply or 15 extract ducts may be connected. Choose either the round or elliptical distribution box depending on what model of pipe you used. Mounting brackets and blanking caps are supplied to seal unused ports.

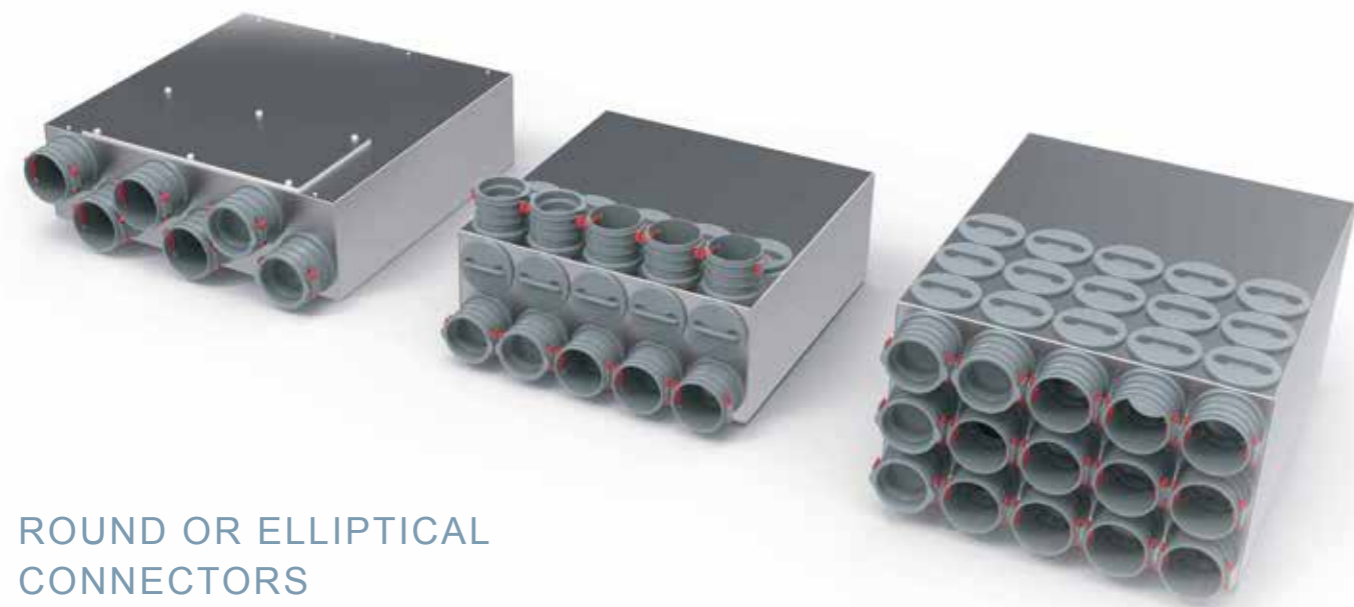

ROUND OR ELLIPTICAL CONNECTORS

You can mix and match round and elliptical connectors on your distribution box, but the boxes are not supplied with mixed connectors. Any alternate connectors will need to be purchased separately.

10 PORT DISTRIBUTION BOX

This durable distribution box has 20 duct connection options either in-line or at 90 degrees. Any configuration of up to 10 supply or 10 extract ducts may be connected. Choose either the round or elliptical distribution box depending on what model of pipe you used. Mounting brackets and blanking caps are supplied to seal unused ports.

AIRFLEXPRO CONFORMS

The Building Regulations Approved Document F1 Means of ventilation prescribes minimum ventilation provisions for new buildings and all notifiable repair, maintenance and improvement (RMI) works in England and Wales. Similar regulations exist in Scotland and Northern Ireland.

There are four primary ventilation systems specified for a residential dwelling and SYSTEM 4 details Mechanical Ventilation with Heat Recovery.

In addition to the Building Regulations there is a companion document, the Domestic Ventilation Compliance Guide 2010 with amendments in 2013 which provides recommended guidance to Best Practise installation of MVHR units and their air duct systems.

Reproduced below are some of the key points in the guide referring to duct installation with our notation highlighting the proven advantages of specifying and installing AirflexPro to meet and exceed the requirements of a Best Practise installation.

DUCT INSTALLATION – GENERAL NOTES

- Ducts should be sized to minimise pressure loss and noise generation. This is achieved by sizing the ducts to limit the air velocity.

75 mm ducts are designed to be smaller and sized appropriately for your system. In addition to this, noise is reduced through the use of AirflexPro clips.

- The routing of ducts should aim to minimise overall duct length and minimise the number of bends required. It is particularly important to minimise bends in main ducts operating at higher air velocities.

AirflexPro when using its connections has been engineered in order to reduce performance loss at bends as much as possible.

- The need for privacy (acoustic separation) should be considered when planning duct layout. Characteristic of AirflexPro ducting system complies as noted in supplementary information, therefore no extra costing required for acoustic attenuation.

AirflexPro radial ducting layout will achieve acoustic separation more effectively than a basic branch layout.

- Consideration should be taken to all room supply and extract valves / grills concerning accessibility. This is for system commissioning purposes and future system cleaning. In rooms such as kitchens, that generate high levels of airborne contaminants, it is recommended that extract valves are fitted with basic filters.

AirflexPro features an internal antibacterial lining, combined with your Airflow Developments MVHR unit can remove over 80% of airborne pollutants. We also have valves (90000318) with built in filters for extra protection.

- Ducting should be insulated where it passes through unheated areas and voids e.g. loft spaces. Most systems have a majority of the ducting placed inside the loft insulation, therefore reducing the cost of insulating the ducting.

AirflexPro semi rigid combines plasticity with performance allowing you more options when it comes to running your pipes through loft insulation. In addition Airflow offers specific insulation for wrapping around AirflexPro duct.

- Ducts should not be installed where they can be damaged, for example open loft areas where they may be stood on or have items placed on them, breaking seals and possibly crushing the duct.

AirflexPro has a crushability resistance of 10 kN/m². (0,016 MPa), higher than is generally required for this application, this reduces the possibility of damage compared to other ducting products.

- Connection of components should not result in significant air flow resistance. Components should be proprietary and fit easily together without distortion.

All AirflexPro components and connections are designed to reduce system resistance, Connection components are made of rigid plastic resistant to distortion, and are inter compatible.

- All duct connections require sealing by a non hardening sealant. Where ducts are installed in or against a solid structure this can be difficult to achieve. In such locations pre-assembly of duct sections should be considered. This will require connections to be permanent ensuring the seal is maintained during installation.

AirflexPro zero leakage feature satisfies compliance and offers reduced labour costs to install.

- Where access to ducts will not be possible after construction is complete .i.e. within floors and wall voids, consideration should be given to permanent connection and sealing with an appropriate non-hardening sealant, and not using duct tape to achieve connection and sealing.

AirflexPro components have been designed with maintenance in mind, with distribution boxes and plenum's giving access.

MULTIPLExBOX - INTELLIGENT AIR DISTRIBUTION



OUR MOST ADVANCED ALL IN ONE DISTRIBUTION BOX YET!

By combining four key air management features into one compact air distribution box the MultiPlexBox ensures exceptional ventilation control in maisonettes, flats and apartment blocks where the buildings ventilation requirements are supplied from a central source. The primary Mechanical Ventilation with Heat Recovery (MVHR) unit may be installed in a basement, plant room or on an enclosed roof top and ducted to each dwelling.

Installing a single, compact, low profile MultiPlexBox that can handle both supply and extract air centrally ducted to the apartment, enables the occupant to benefit from four key options to individually regulate their own indoor environment.

- On-demand air volume control within the home.
- Whisper silent air movement throughout the dwelling.
- Up to seven AirflexPro supply and seven extract radial ducting room connection options for comprehensive ventilation.
- Easy to use automatic and manual wall mounted control panel options.
- Optional VOC and humidity sensor to help protect against Toxic Home Syndrome.

As each MultiPlexBox is independently controlled within the dwelling each occupant becomes self-sufficient from the central air handling unit. This means each dwelling has the flexibility of setting their own indoor ventilation preferences by the user and adjusting either manually or automatically to meet the demands of their own lifestyles.

In addition to the standard inbuilt features, an optional Volatile Organic Compound (VOC) with humidity sensor can be integrated into the box to provide an even higher level of ventilation demand control based on monitoring the indoor air quality. The personal health and wellbeing issues surrounding Toxic Home Syndrome are now well understood and this increased level of control will help mitigate the potentially harmful effects of breathing noxious gasses and airborne particulates.

The MultiPlexBox is used in conjunction with the **AirflexPro** ducting and components to provide a low energy leak free system.



Always fits
The right box for every requirement. Whether for ceiling or wall installation. AirflexPro is compatible with MultiPlexBox.

Quick installation
One single compact box is installed rather than numerous individual components. With its integrated mounting bracket, it is also fixed into place in no time.

Brilliantly quiet
The large-scale sound attenuation elements ensure silent operation. Thus, the MultiPlexBox is especially suited for noise sensitive environments.

Maintenance
Expendable and wear parts have been avoided in the design of the MultiPlexBox. However, the integrated inspection opening makes it easy to make sure that "all is well" if desired.

All automatic
The optional room air sensors turn the MultiPlexBox into a complete demand driven ventilation unit. Manual user intervention is not required.

Unique
The revolutionary technology safely ensures the predefined volume flow independently, continuously and with the highest precision.

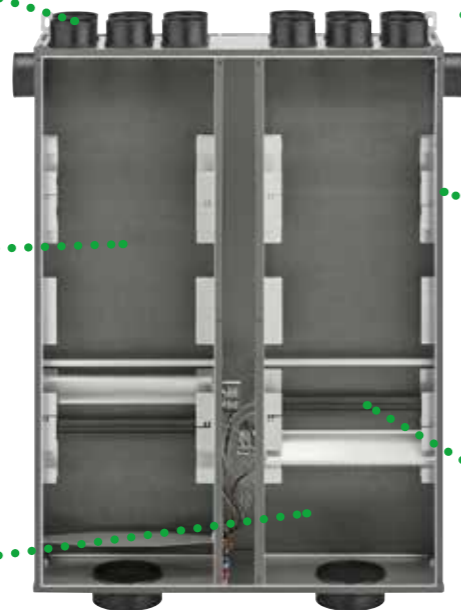

MULTIPLExBOX



KEY FEATURES

- Individual dwelling air flow control from a central (external) air handling unit.
- On-demand control either manually or automatically from a wall mounted control panel.
- Expected sound levels in rooms, no more than 23 dB for excellent acoustic absorption and a whisper quiet indoor air movement.
- Quick to fit and easy to locate slim profile for installation in narrow ceiling joists and voids, wall cavities and inside cupboards or confined spaces.
- Two simple to use control panel options for ease of operation and setting air flow preferences.
- Compatible with AirflexPro semi rigid ducting connections but can also be used with spiral and rigid plastic ducting.
- Three compact versions available with 2 to 6 AirflexPro connection and orientation options.
- Virtually maintenance free but designed with an inspection cover giving easy access for cleaning internal parts.

TECHNICAL

Specification	MultiPlexBox
Supply Airflow	11 l/s to 61 l/s
Extract Airflow	11 l/s to 61 l/s
Volume flow	40 m³/h to 220 m³/h
Pressure loss for the MultiPlexBox @55ls	79 pa
Airflow Tolerance	+/- 4 m³/h
Maximum noise level	23 dB
Suitable for dwellings up to	230 m²
Weight	25 kg
Power Supply	230 V / 1 PH / 50 Hz
Power Consumption	6 W
Ingress protection	IP40
Setting steps	on the control panel +/-3 m³/h
Unit Supply Ports	2 x 125 Ømm

COMMISSIONING AND CONTROL

Software that leaves nothing to be desired.

The commissioning of the MultiPlexBox is convenient and fast thanks to the intuitive PC software:

- Start software > Enter air volumes > Done!
Complex and time consuming pressure difference measurement is eliminated.
- Individual fine-tuning: Various additional configuration options are available where required.
- Once set, the defined parameters can be saved on the PC and transferred to other boxes.

Smart thing; The box in the network.

All boxes can be combined in one network and centrally managed. It could not be any more convenient!

- The MultiPlexBox software enables the central commissioning of all boxes in the network.
- The Ultimate solution: **The highly efficient fan-optimiser.** With this technology, the performance of the central ventilation unit is permanently co-ordinated with the changing conditions at each MultiPlexBox. Precisely the required air volume - individual for each moment. This reduces the energy consumption without any comfort restrictions.

MULTIPLExBOX



CONTROL OPTIONS

Sensor supported operation

Extremely convenient “hands-off” operation: once set, operation is always perfect.

- Sensors for demand-controlled ventilation.
- Intelligent solution for user-independent operation.
- Available as an air humidity sensor or as a combi sensor with additional VOC detection.
- Automatic and continuous assurance of the necessary air volumes.
- Sensors directly installed in the MultiPlexBox.

Basic Controller

A solution that is just as economical as functional for manual or automatic operation.

- Functional and discreet LED control panel in the compact switch dimensions (80 x 80 mm).
- Individual, manual operation: Choice of four ventilation stages with freely definable air volumes.
- Automatic operation: The MultiPlexBox adjusts the air volume to the demand (using sensor, optional).
- Full power in no time at all: Activation of intensive ventilation quickly ensures the best air quality (party ventilation).

Touchscreen Controller

High quality control element with the touch-screen also enables the creation of an individual weekly programme.

- Design control panel with real glass surface.
- Intuitive, manual operation: The MultiPlexBox adjusts the air volume to the demand (using sensor, optional).
- Displays all important parameters, e.g. the current ventilation stage and temperature.
- Creation of an individual weekly programme.

Universal control

The universal control device is for networking different MultiPlexBoxes and a ventilation unit together. Using this technology the entire ventilation system can run in optimal conditions automatically and remotely. The universal control device also enables the central command of up to 255 units using a single computer and significantly saves you time spent on site.

The device works by enabling the ventilation unit to control its flow rates and the MultiPlexBox to control its internal air regulation according to your local air conditions. The system is continuously adjusted through sensors to give you the best airflow rates, and offers optimal performance paired with efficient energy consumption. This also results in the reduction of sound output, as the unit will never run more than it needs to.



MECHANICAL VENTILATION WITH HEAT RECOVERY



A whole house, continuously operating Mechanical Ventilation system with Heat Recovery (MVHR) from Airflow provides the supply of controlled, fresh, filtered air while extracting potentially harmful and unwanted dampness, moisture and air borne particulates. It helps save energy too by reclaiming waste heat from the extracted air which would otherwise be lost. By returning it into the dwelling warming the fresh, filtered incoming air, a healthier indoor environment is created for all.

Having up to 90% thermal efficiency, Duplexvent Adroit units provide a hygienic and comfortable environment at all times. With our Passive House Institute certified and SAP Q eligible models, Duplexvent Adroit is the perfect choice for your whole house ventilation.

These Mechanical Ventilation with Heat Recovery units are available with a unique triple filter system ensuring healthy and fresh indoor air. All units offer automatic summer by-pass and have the option of smart frost protection.

Adroit units enable remote control and monitoring of the unit's ventilation and through the Adroit Cloud Service, offer advanced control functions. The Adroit digital controller has advanced functionality integrated into intuitive icons. The ventilation control is based upon four profile options: Home, Away, Boost and Fireplace. The Adroit Cloud Control is a remote-control option throughout the Internet.

AIRFLOW ADROIT

- | | |
|--------------------|-----------------------------|
| ENERGY RECOVERY | FROST PROTECTION |
| CLOUD CONNECTIVITY | NATURAL FILTERING SOLUTIONS |
| SUMMER BYPASS | |



RETRO DUCTING – DISCREET COVING DUCTING



This versatile and innovative ducting is designed around a coving system that can be incorporated within the visible part of the house or flat and is ideally suited to a standard footprint building design where there is a common entrance hallway with all the rooms branching off the hallway. It can be painted to blend in seamlessly with an occupant's décor and negates the need for suspended ceilings to hide duct work.

Retro ducting is lightweight, versatile, and easy to fit whilst also saving 40% installation time over conventional ducting systems. Retro Duct is fire retardant to EU-B2 rating DIN 4102.

Product Description	Port Connections	Part Number
Combination distribution box right handed	ø100 mm to rooms, ø125 mm to unit	90000275
Combination distribution box left handed	ø100 mm to rooms, ø125 mm to unit	90000276
Airflex Retro duct with stucco profile	ø100 mm x 1 m Length	90000277
Airflex Retro long connector set with clamp/wall mount bracket	Ø100 mm	90000278
Airflex Retro T piece with stucco profile	Ø100 x 100 x 100 mm	90000279
Airflex Retro short connector with seals	Ø100 mm	90000280
Airflex Retro inner angle with stucco profile	Ø100 x 100 mm	90000281
Distribution Box sealing cap with seal	Ø100 mm	90000282
Airflex Retro outer angle with stucco profile	Ø100 x 100 mm	90000283
Airflex Retro wall connecting pipe PVC	Ø100 mm	90000284
Coanda valve for supply air with seal	Ø100 mm	90000285
Square supply/extract valve with filter (closed front)	Ø100 mm connection 135 x 135 mm	90000315
Square supply valve with filter (open front)	Ø100 mm connection 135 x 135 mm	90000439
Airflex Retro duct with square profile	Ø100 mm x 1 m Length	90000445
Airflex Retro T piece with square profile	Ø100 x 100 x 100 mm	90000446
Airflex Retro inner angle with square profile	Ø100 x 100 mm	90000447
Replacement filter for 90000315 and 90000439	Pack of 5	90000317



ISO DUCTING – AN INSULATED DUCTING SYSTEM



The ISO Duct has a thermal conductivity of 0.042 W/mK and has been engineered to work as a complete system ensuring all components are easily connected with one another. As a great alternative to spiral ducting installation it saves up to 70% assembly time and is quick to mount. All components are

water vapour tight and impact resistant made with antistatic Polyethylene foam. ISO helps avoid condensation build up and is perfect for intake and extract ducting, including those in cold temperature.

Note: External and internal connectors will offer the same performance.

Product Description	Part Number
ISO Duct Ø125 mm x 2000 mm Length with external connector (Plastic)	9041147
ISO Duct Ø160 mm x 2000 mm Length with internal connector (Plastic)	90000465
ISO Duct Ø180 mm x 2000 mm Length with internal connector (Plastic)	90000475
ISO Duct Ø200 mm x 2000 mm Length with internal connector (Plastic)	90001277
ISO Duct Ø125 mm 45° elbow with external connector (Plastic)	9041154
ISO Duct Ø125 mm 90° elbow with external connector (Plastic)	9041152
ISO Duct Ø160 mm 45° elbow with internal connector (Plastic)	90000466
ISO Duct Ø160 mm 90° elbow with internal connector (Plastic)	90000467
ISO Duct Ø180 mm 45° elbow with internal connector (Plastic)	90000476
ISO Duct Ø180 mm 90° elbow with internal connector (Plastic)	90000477
ISO Duct Ø200 mm 45° elbow with internal connector (Plastic)	90001347
ISO Duct Ø200 mm 90° elbow with internal connector (Plastic)	90001278
ISO Duct Ø125 mm external connector (Metal)	9041191
ISO Duct Ø160 mm internal connector (Plastic)	90000468
ISO Duct Ø160 mm internal connector (Metal)	90000469
ISO Duct Ø180 mm internal connector (Plastic)	90000478
ISO Duct Ø200 mm Internal connector (Metal)	9041232
ISO Duct Ø200 mm internal connector (Plastic)	90001348
ISO Duct Ø200mm mounting clamp (Metal)	90001349
ISO Duct Ø160 mm female to Ø125 mm male reducer connector (Metal)	9041163
ISO Duct Ø160 mm male to Ø125 mm female reducer connector (Metal)	90000470
ISO Duct Ø160 mm male to Ø180 mm female reducer connector (Metal)	90000471
ISO Duct Ø160 mm male to Ø200 mm female reducer connector (Metal)	90001346
ISO Duct Ø180 mm male to Ø160 mm female reducer connector (Metal)	90000480
ISO Duct Ø180 mm male to Ø200 mm female reducer connector (Metal)	90000500
ISO Duct Ø200 mm male to Ø180 mm female reducer connector (Metal)	90001279
ISO Duct Ø250 mm male to Ø200 mm male reducer connector (Metal)	90001280



ISO DUCTING – TECHNICAL INFORMATION

ISO pipe can satisfy airflow requirements listed in part F when paired with our MVHR units and offers up to 70% in-site time saved.

Technical Specification	Value
Thermal Conductivity	0.042 W/mK
Operating Airflow Temperatures	-25 to 80 °C
Fire Rating	B1 or B2 Rating*
Max Airflow capacity	138.8 l/s
Material	Anti Static polyethylene Foam or brushed steel
Inner Material	Smoothbore, with airtight seals and connectors
Length per pipe	2000 mm
Spigot Compatibility	Ø125 mm, Ø160 mm, Ø180 mm, Ø200 mm
Connection	Watertight, airtight
Testing Certificates	EN 13501-1, DIN 4102, DIN 52612-2

*external connectors are rated at B2

Our ISO ducting range complies to several key conditions in the UK and EU building regulations:

- Complies to approved Document B (Fire safety) – Volume 1: Dwellings (2019 edition)
- Easily enables a system to achieve the airflow rates in part F approved document table 5.1a and 5.1b.
- ISO Ducting can be used to meet the recommendations for ductwork listed in ventilation compliance guide table 7 - 2.0, sections a, b, c, d and section 2.0 (ductwork continued 1) a, b, c, d, e and f.

CONNECTIONS AND FITTINGS

Please refer to the diagrams below for an explanation of how an ISO pipe system works together.

Figure 1: Reducer



MALE AND FEMALE REDUCERS

Male connections feature a gasket to ensure an airtight seal when inserted into ISO ducting. The female socket pushes over the gasket on the distribution box.

Figure 2: Internal and External Connections

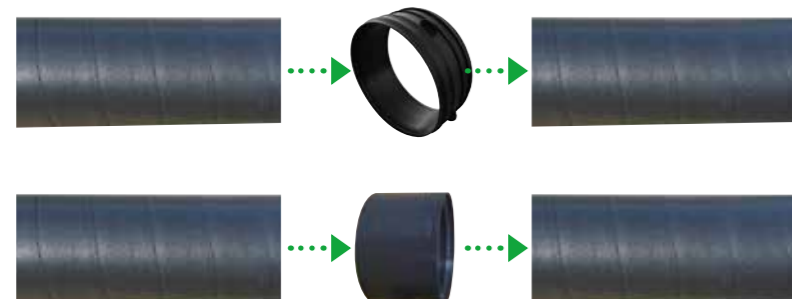

EXTERNAL AND INTERNAL CONNECTIONS

125 mm connections are facilitated exclusively by external connections, connections for larger sizes are facilitated exclusively by internal connections. Both offer identical performance.

ISO DUCTING – TECHNICAL INFORMATION

EFFICIENT

With airflow rates up to 138.8 l/s and thermal conductivity of 0.042 W/mK combined with resistance to air temperatures of -25 to 80 °C. This duct can deliver on the performance you need for airflow MVHR units and enable you to offer a solution for insulation requirements. Its smooth bore inner surface is not

only sound absorbing but helps make maintenance an ease. The ISO duct is antistatic which will prevent build-up of dust particles and keep maintenance of the pipe hassle free.

EASY

ISO Pipe can save up to 70% of assembly time compared to other products on the market and is quick to mount with all components compatible with connectors, collars, elbows, and adapters for going from smaller to larger diameters and vice versa. These products have been designed to be airtight and

quickly connected for an easy installation process. The in-built internal connectors can be unpacked and screwed on without hassle. With a high crushability resistance, the robust duct ensures a low chance of damage on site.

SAFE

Our ISO ducting is made of polyethylene foam which is watertight, anti-static and an insulator. This material has been fire tested to German standard DIN 4102 and British Standard EN 13501-1, achieving a B1 rating which is compliant to Part B building regulations.

product on a range of characteristics, including combustibility, heat levels, flame spread and smoke release, this rating means this product has "limited contribution to fire spread". Expanded polyethylene (EPE) is resistant to condensation forming in the duct which could result in water unsafely entering electrical equipment.

The process for classification under this standard involves a combination of up to five rigorous tests designed to assess the

ADVANTAGES

- Pre-insulated one-piece.
- Quick and easy assembly.
- Tough, durable, anti-static EPE and Steel.
- Fire retardant to B1 and B2.
- Avoids condensation build up.
- Sound absorbing, smooth bore pipe.
- Choice of components to suit any layout.
- Compatible with Airflow MVHR to deliver on performance and reliability.
- Reliable ductwork with good crushability characteristics.
- Easy maintenance.
- Hassle free connection on site.

AIRFLEXPRO SPECIFICATION

	AirflexPro Round
Inner Diameter	63 mm
Outer Diameter	75 mm
Duct Thickness	6 mm
Max. Air Volume (allowed)	30 m ³ /h
Max. Air Velocity (allowed)	2.7 m / s
Max. Pressure Drop (allowed)	3 Pa /m
Noise Absorption (of distribution boxes)	>15 dB according to DIN EN ISO 11820
Material	"Outside Polyethylene PE-HD, Inside Polyethylene PE-LD, antistatic, antibacterial, non-toxic"
Fire Rating	B2, normally inflammable according to DIN 4102
Crushability	10 kN / m ²
Operation Conditions	from -5°C to +90°C
Inside Bending Radius	153 mm
Length Per Coil	50 m
Connection With Sealing Ring	air- and watertight according to DIN EN 1610
Part No: 50 m coil	9041130



	AirflexPro Elliptical
Inner Diameter	102 x 39 mm
Outer Diameter	114 x 51 mm
Duct Thickness	6 mm
Max. Air Volume (allowed)	30 m ³ /h
Max. Air Velocity (allowed)	2.7 m / s
Max. Pressure Drop (allowed)	3 Pa /m
Noise Absorption (of distribution boxes)	N/A
Material	"Outside Polyethylene PE-HD, Inside Polyethylene PE-LD, antistatic, antibacterial, non-toxic"
Fire Rating	DIN 4102-4 Class B2 & EN 13501-1 Class E
Crushability	10 kN / m ²
Operation Conditions	from -5°C to +90°C
Inside Bending Radius	Horizontal: 342 mm / 200 mm Vertical
Length Per Coil	20 m
Connection With Sealing Ring	air- and watertight according to DIN EN 1610
Part No: 20 m coil	90000255



	Duct Clips
Part No: Round Duct (Pack of 10)	90000352
Part No: Elliptical Duct (Pack of 10)	90000353
	Spare Holding Clips
Part No: Pack of 10	90000261
	Packet of Sealing Rings
Part No: Round (Pack of 10)	9041133
Part No: Elliptical (Pack of 10)	90000254

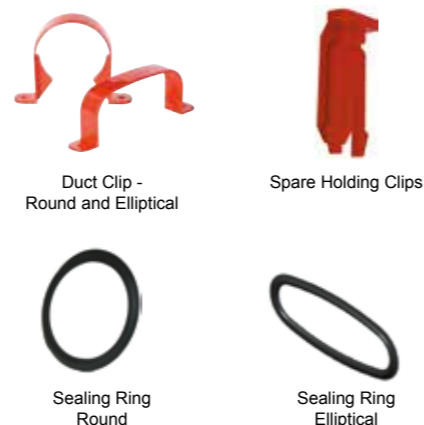

CONCRETE APPLICATION

INSTALLATION IN CONCRETE SCREEDS

The durable, ribbed outer skin of AirflexPro offers excellent flexibility, strength and compressibility, up to 10 kN / m². These properties make it ideally suited for embedding straight into concrete screed without distortion, which ensures predicted airflow rates through ducts are maintained.

Having an inherently small bend radius (as little as 150 mm. See page 11) allows for an easy and cost-efficient duct layout design. It is recommended that the duct is held in position by tying it to nearby rebar grids or by using Airflows unique duct clips, at a maximum spacing distance of 750 mm. All joints should be taped up, stopping any ingress of screed or concrete into the joint.



INSTALLATION ON CONCRETE SURFACES

AirflexPro elliptical ducting perfectly complements AirflexPro round. Its small cross-sectional dimensions of 51 x 114 mm, make it suited to shallow construction depths within walls and floors, including insulation base layers, where the AirflexPro round profile is too large. There is also no restriction on whether the duct is placed horizontally or vertically, it works in any plane.

Note: AirflexPro elliptical is only suitable to be laid under concrete floor screed up to 35 mm thick (See: Typical AirflexPro elliptical installation in basic concrete ceiling) . For applications where the depth of concrete / screed is deeper, AirflexPro round should be used. See chart below:

Design Features	Property Type								
	Single Family Home			Buildings upto 5 x Storeys F30 - A			Buildings upto 5 x Storeys F90 - A		
	d ₁	d ₂	d ₃	d ₁	d ₂	d ₃	d ₁	d ₂	d ₃
Minimum over cover*	50 mm			50 mm			50 mm		
Minimum shortfall		50 mm			80 mm			100 mm	
Minimum distance between pipes			DN			DN			DN
Recommended minimum cover thickness without consideration of cable crossing	d = 180 mm			d = 220 mm			d = 240 mm		
Recommended minimum cover thickness including cable crossing	d = 200 mm			d = 240 mm			d = 260 mm		

DN = Duct diameter or see manufactures instructions
 * = Value has only an installation of a floating screed with a minimum thickness of 25 mm
 Data in the table are also valid in the case of leaching in local areas

Accepted load on AirflexPro Round Duct + 10 Kn / m²
 Load = force area
 Load for 1 m³ concrete = 2400 Kg (average) x 1 m² = 2400 Kg / m²
 Mass = Density x Volume = 2400 x 1 m³ = 2400 Kg / m³
 Force = (Density x Volume) x Gravity = (2400 x 1) x 9.81
 Height of concrete = 1300 N / m²
 2400 x 1 x 9.81 = 0.552 metres

BRE PRODUCT CHARACTERISTICS DATABASE LISTED

SAP Q ELIGIBLE

AirflexPro has been assessed by the Building Research Establishment (BRE), an independent product testing organisation, and listed in the Product Characteristics Database in the semi rigid ducting category.

For use with Standard Assessment Procedure protocols as defined in SAP Q which state that semi rigid ducting (unjointed) has at least an equal or better performance than equivalent rigid ducting.



Product Tested	Test Sample A
Serial number of product test	XYZ
MVHR to outside grille duct sizes and type	K+1 & K+2 - 125 mm diameter rigid plastic K+3 upwards - 150 mm diameter rigid plastic
Duct sizes and types used for supply and exhaust	K+1 & K+2 - 125 mm diameter rigid plastic + Semi rigid 75 mm diameter round K+3 upwards - 150 mm diameter rigid plastic + Semi rigid 75 mm diameter round
Results of leakage tests	
Internal leakage	Nil
External leakage	Nil

SAP Q ELIGIBLE TESTING RESULTS

Exhaust Terminal Configuration	Fan Speed Setting	Total Supply Flow Rate (l / s)	Total Exhaust Flow Rate (l / s)
Kitchen + 1 additional wet rooms	100% variable	15.0	15.0
Kitchen + 2 additional wet rooms	100% variable	21.0	21.0
Kitchen + 3 additional wet rooms	100% variable	27.0	27.0
Kitchen + 4 additional wet rooms	100% variable	33.0	33.0
Kitchen + 5 additional wet rooms	100% variable	39.0	39.0
Kitchen + 6 additional wet rooms	100% variable	45.0	45.0
Kitchen + 7 additional wet rooms	100% variable	51.0	51.0

Exhaust Terminal Configuration	Fan Speed Setting	Total Supply Flow Rate (l / s)	Total Exhaust Flow Rate (l / s)	Specific Fan Power (W / l / s)	Heat Recovery Efficiency (%)
Kitchen + 1 additional wet rooms	100% variable	15.0	15.0	0.63	-
Kitchen + 2 additional wet rooms	100% variable	21.0	21.0	0.62	-
Kitchen + 3 additional wet rooms	100% variable	27.0	27.0	0.61	-
Kitchen + 4 additional wet rooms	100% variable	33.0	33.0	0.67	-
Kitchen + 5 additional wet rooms	100% variable	39.0	39.0	0.77	-
Kitchen + 6 additional wet rooms	100% variable	45.0	45.0	0.87	-
Kitchen + 7 additional wet rooms	100% variable	51.0	51.0	1.04	-

RESULTS AT MAXIMUM FLOW RATE CONDITION

RESULTS AT MINIMUM FLOW RATE CONDITION

AIRFLEXPRO ROUND AND ELLIPTICAL DUCTING CLIPS

AIRFLEXPRO ROUND

AIRFLEXPRO ELLIPTICAL

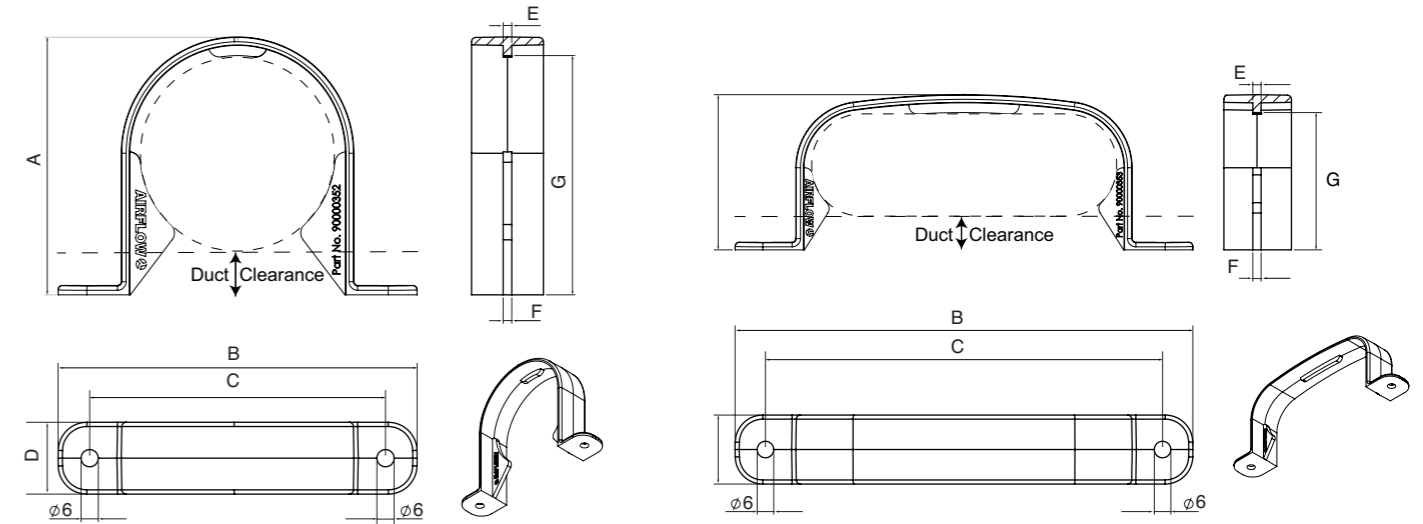

Model	A	B	C	D	E	F	G
AirflexPro Round	89.9	125	103	25	3	3	83.3
AirflexPro Elliptical	56.3	166	144	25	3	3	49.8



COMPONENTS



Spare Holding Clips

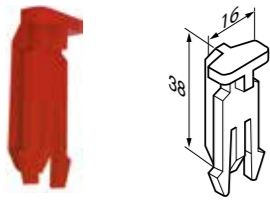

Part Number - 90000261
(pack of 10).

Elliptical Spigot Connection

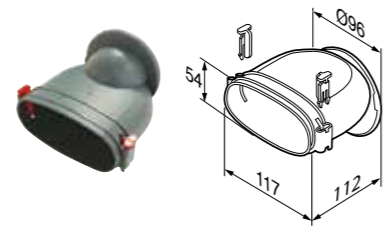

Part Number - 90000259
Elliptical Spigots for
Distribution Boxes.

Round Spigot Connection

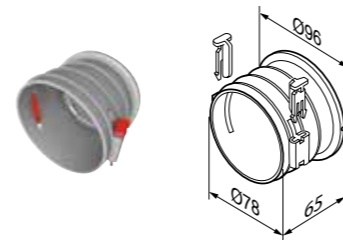

Part Number - 90000260
Round Spigots for
Distribution Boxes.

Straight Connection Piece

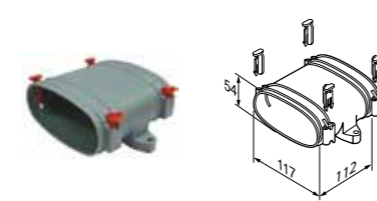

Part Number - 90000253
54 x 117 mm
Straight connector elliptical-elliptical.

COMPONENTS



90° Vertical Transition Piece

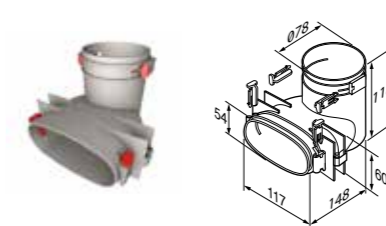

Part Number - 90000251
90° Vertical Transition Piece
(round-elliptical).

Straight Transition Piece

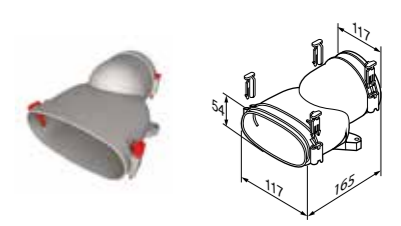

Part Number - 90000252
Straight Transition Piece
(round-elliptical).

Bayonet Cap - Distribution Box



Part Number - 90000258
96 mm Sealing Cap for
Spigot Holes in Distribution Boxes.

Hygienic Caps

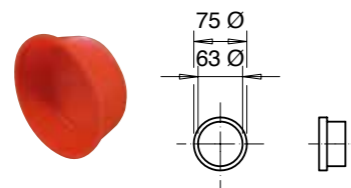

Part Number - 9041131
Hygienic cap for AirflexPro round
(pack of 10).

Straight Connection

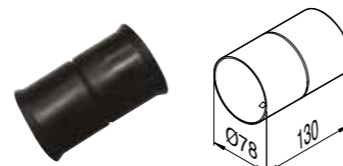

Part Number - 9041132
Connects AirflexPro round to AirflexPro
round.

90° Vertical Elbow

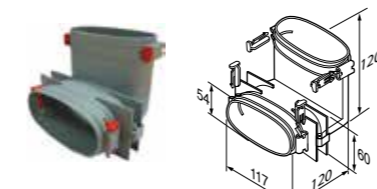

Part Number - 90000247
54 x 117 mm
Vertical elbow (elliptical-elliptical).

90° Horizontal Elbow

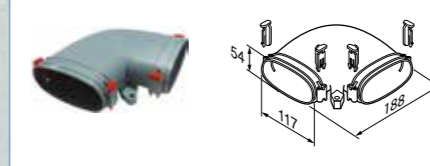

Part Number - 90000248
54 x 117 mm
Horizontal elbow (elliptical-elliptical).

Ceiling or Wall Plenum Elliptical

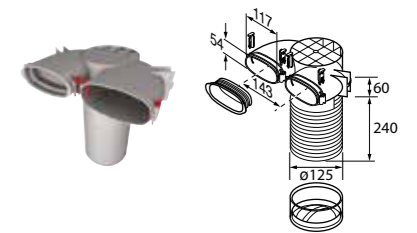

Part Number - 90000249
54 x 117 mm 90° Ceiling / Wall Plenum
Connects AirflexPro elliptical through
the ceiling to the extract / supply valve.
Can be cut down for varying height of
void.

90° Compact Elbow

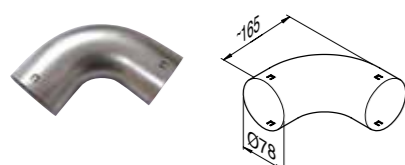

Part Number - 9041139
75 mm dia allows very small bend
radius of duct.

Straight Ceiling Outlet

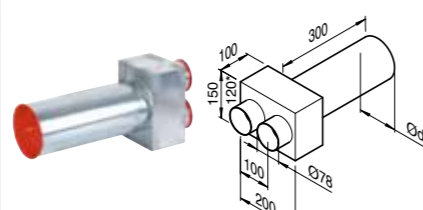

Part Number - 9041141
2 spigots for 75 mm piping and
one spigot (125 mm) for extract or
supply valve.

90° Floor Outlet

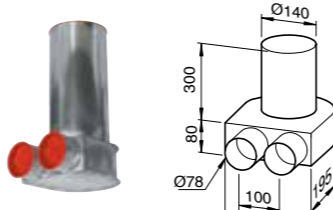

Part Number - 9041142
2 spigots for 75 mm piping and
one spigot (140 mm) for floor grille
(9041174).

Ceiling or Wall Plenum Round



Part Number - 90000250
75 mm 90° Ceiling / Wall Plenum
Connects AirflexPro Round through
the ceiling to the extract / supply valve.
Can be cut down for varying height of
void.

Sealing Rings Elliptical



Part Number - 90000254
54 x 117 mm dia
AirflexPro elliptical Sealing
Ring (pack of 10).

Sealing Rings Round



Part Number - 9041133
75 mm dia. AirflexPro
Round Sealing Ring
(pack of 10).

COMPONENTS



90° Wall Outlet

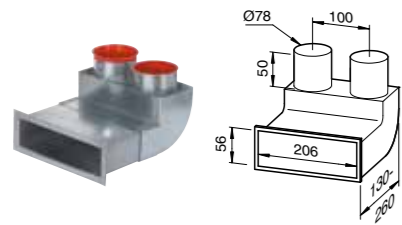

Part Number - 9041144

2 spigots for 75 mm piping and 200 mm x 50 mm opening for wall grille (9041175).

Straight Wall Outlet

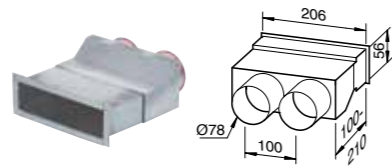

Part Number - 9041143

2 spigots for 75 mm piping and 200 mm x 50 mm opening for wall grille (9041175).

90° Floor Outlet - Round

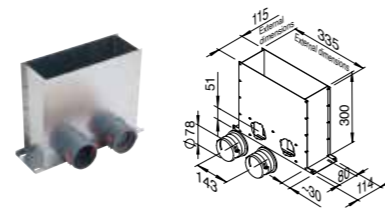

Part Number - 90000441

2 Spigots for 75 mm piping suitable for stainless steel floor grille (0000440).

90° Wall / Floor / Ceiling Outlet-Elliptical

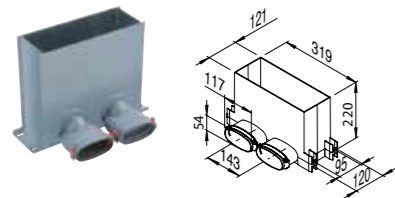

Part Number - 90000525

2 Spigots for 54 x 114 mm Elliptical piping suitable for grilles 90000440 / 90000526 / 90000527 / 90000528 / 90000529 / 90000530 & 90000531

5-Port Distribution Box (elliptical)

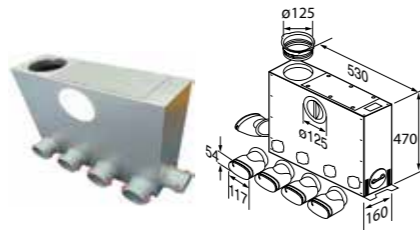

Part Number - 90000262

5-Port Distribution Box (round)

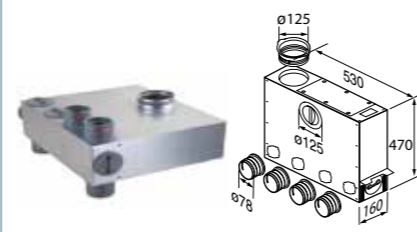

Part Number - 90000263

10-Port Distribution Box (round)

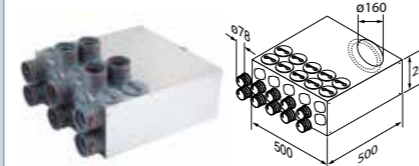

Part Number - 90000266

15-Port Distribution Box (round)

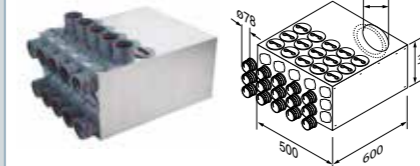

Part Number - 90000269

Combi Distribution Box (L/H)

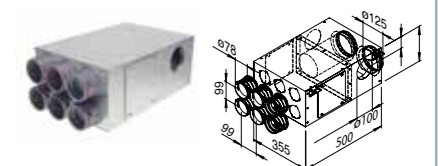

Part Number - 90000443

Enables supply and extract simultaneously connects to AirflexPro round 75 mm (up to 6 spigots) inlet 125 mm handed inlet.

Combi Distribution Box (R/H)

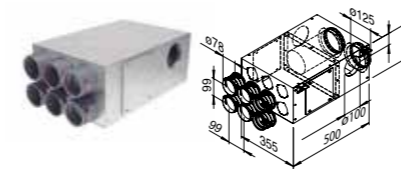

Part Number - 90000444

Enables supply and extract simultaneously connects to AirflexPro round 75 mm (up to 6 spigots) inlet 125 mm handed inlet.

Combination Distribution Box Supply Air Right

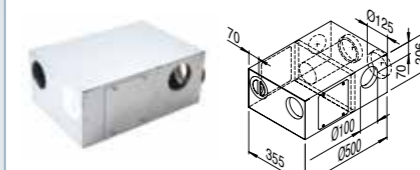

Part Number - 90000275

125 / 100 / 100 mm dia.

Combination Distribution Box Supply Air Left

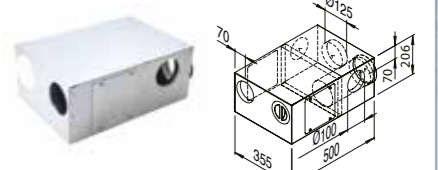

Part Number - 90000276

125 / 100 / 100 mm dia.

6-Port In-Line Narrow Distribution Box (round)

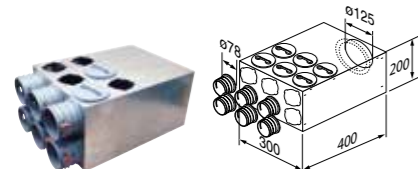

Part Number - 90000265

6-Port In-Line Distribution Box (round)

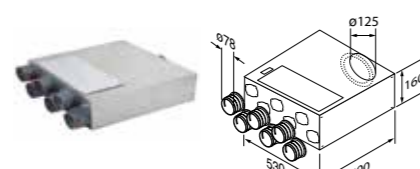

Part Number - 90000264

10-Port Distribution Box (elliptical)

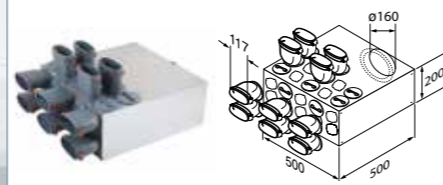

Part Number - 90000270

Mounting Brackets



Part Number - 9041139

All distribution boxes supplied with mounting brackets. Supplied loose for ease of onsite installation.

Round Cowl with Louvers



Part Number - 9041226

ø125 mm

Part Number - 52644601

ø150 mm

Round Cowl with Mesh

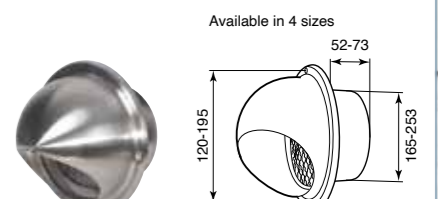

Part Number - 9041228 ø125 mm

Part Number - 52644801 ø150 mm

Part Number - 90000506 ø160 mm

Part Number - 9041229 ø180 mm

COMPONENTS

Regal Side Entry Cowl

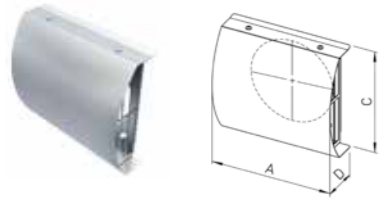

Part Number - 90000449
To suit ϕ 125 mm ISO duct - A 230 mm D 78 mm C 200 mm

Part Number - 90000498
To suit ϕ 160 mm ISO duct - A 265 mm D 97 mm C 240 mm

Part Number - 90000501
To suit ϕ 180 mm ISO duct - A 285 mm D 126 mm C 260 mm

Regal Front Entry Cowl



Part Number - 90000450
To suit ϕ 125 mm ISO duct - A 230 mm B 157 mm C 200 mm D 78 mm

Part Number - 90000499
To suit ϕ 160 mm ISO duct - A 265 mm B 192 mm C 240 mm D 97 mm

Part Number - 90000502
To suit ϕ 180 mm ISO duct - A 285 mm B 212 mm C 260 mm D 126 mm

Coanda Supply Air Valve - White

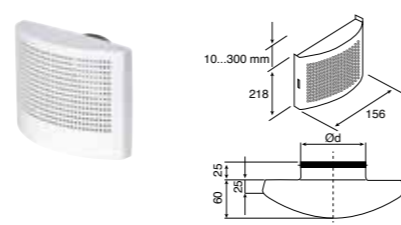

Part Number - 90000285
 ϕ 100 mm

Part Number - 9041166
 ϕ 125 mm

Aluminium Wall Grille

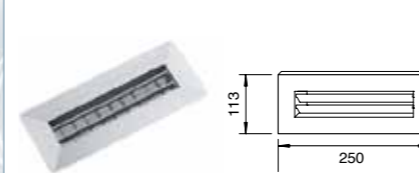

Part Number - 9041175

For wall mounting 200 x 50 mm (inner), 250 x 110 mm (outer) Air volume adjustable via horizontal and vertical fins fits with straight wall outlet (9041143) and 90° Wall outlet (9041144) also fits to 204 mm x 60 mm ducting.

COMPONENTS

Floor Grille - Satin Stainless steel

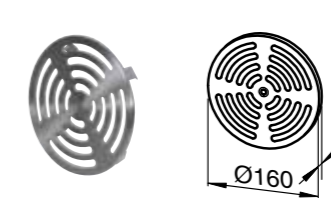

Part Number - 9041174

Floor grille from satin stainless steel air volume adjustable via setting disc fits with floor outlet (9041142).

Stylish Supply / Extract Valve

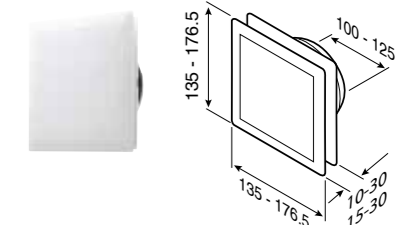

Part Number - 90000315
 ϕ 100mm Square supply/extract adjustable valve with filter.

Part number - 90000316
 ϕ 125mm Square supply/extract adjustable valve with filter.

Plastic Adjustable Air Valve (Supply)



Part Number - 90000339
 ϕ 125 mm Directional supply

Direct the airflow from this adjustable and lockable supply valve to any area in the room.

Metal Adjustable Air Valve (Supply)



Part Number - 9041168
 ϕ 125 mm

White powder coated lockable supply valve.

Plastic Adjustable Air Valve (Extract)

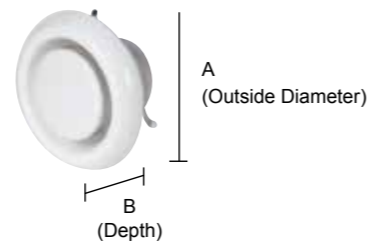

Part Number - 90000340
 ϕ 125 mm (A-165 x B-65 mm)

White plastic lockable extract valve.

Brushed Stainless Steel Floor Grille

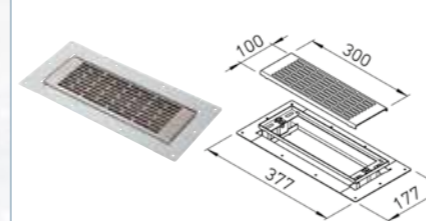

Part Number - 90000440
300 x 100 mm Suitable for outlets 90000441 and 90000525.

White Powder Coated Grilles

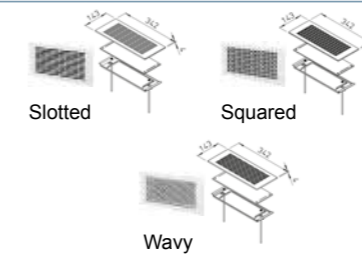

Part Number - 90000526 Slotted
Part Number - 90000527 Squared
Part Number - 90000528 Wavy

Brushed Stainless Steel Grilles

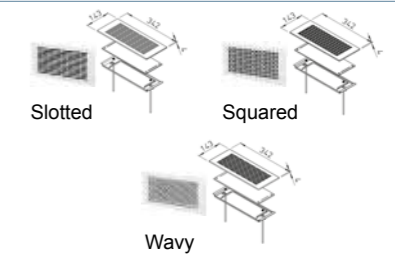

Part Number - 90000529 Slotted
Part Number - 90000530 Squared
Part Number - 90000531 Wavy

All suitable for 90000525.

Metal Adjustable Air Valve (Extract)



Part Number - 9041172
 ϕ 125 mm

White powder coated lockable extract valve.

Fire Protection Valve (Extract)



Part Number - 90000126
 ϕ 125 mm

White powder coated, metal, lockable valve with thermal fuse safety feature.

Note: External connectors are only available in $\phi 125$ mm size, and offer identical performance to internal connectors.

COMPONENTS



ISO Pipe (Internal Connection)

Part Number - 90000465
 $\phi 160 \times 2000$ mm - A 160 mm B 192 mm
Part Number - 90000475
 $\phi 180 \times 2000$ mm - A 180 mm B 212 mm
Part Number - 90001277
 $\phi 200 \times 2000$ mm - A 200 mm B TBA
 Comes with internal plastic connector.

ISO Pipe (External Connection)

Part Number - 9041147
 $\phi 125 \times 2000$ mm - A TBA B 157 mm

Comes with external plastic connector.

ISO Pipe

Part Number - 90000468
 $\phi 160$ mm - A 160 mm C 80 mm
Part Number - 90000478
 $\phi 180$ mm - A 180 mm C 80 mm
Part Number - 90001348
 $\phi 180$ mm - A 200 mm C TBA
 Internal plastic connector for ISO pipes.

ISO 90° Degree Elbow

Part Number - 90000467
 $\phi 160$ mm - A 160 mm B 192 mm C 272 mm
Part Number - 90000477
 $\phi 180$ mm - A 180 mm B 212 mm C 292 mm
Part Number - 90001278
 $\phi 200$ mm - A 200 mm B TBA
 Comes with internal plastic connector.

ISO 45° Degree Elbow

Part Number - 90000466
 $\phi 160$ mm - A 160 mm B 192 mm C 242 mm
Part Number - 90000476
 $\phi 180$ mm - A 180 mm B 212 mm C 256 mm
Part Number - 90001347
 $\phi 200$ mm - A 200 mm B TBA C TBA
 Comes with internal plastic connector.

ISO Internal Connector (Metal)

Part Number - 9041191
 $\phi 125$ mm - A 125mm B 70 mm
Part Number - 90000469
 $\phi 160$ mm - A 160 mm B 70 mm
Part Number - 9041232
 $\phi 200$ mm - A 200 mm B TBA
 Internal metal connector with airtight seals.

ISO 90° Degree Elbow

Part Number - 9041152
 $\phi 125$ mm
 - A 125 mm B 157 mm C 255 mm

Comes with external plastic connector.

ISO 45° Degree Elbow

Part Number - 9041154
 $\phi 125$ mm
 - A 125 mm B 157 mm C 239 mm

Comes with external plastic connector.

ISO External Connector (Plastic)

Part Number - 9041149
 $\phi 125$ mm
 - B 157 mm C 104 mm

External connector for 125 mm ISO duct plastic.

COMPONENTS



Metal Reducer Connector with Airtight Seal. (Male with seal to female)

Part Number - 90000470 - A $\phi 125$ mm (M) (GSK) to B $\phi 160$ mm (F)
Part Number - 90000471 - A $\phi 160$ mm (M) (GSK) to B $\phi 180$ mm (F)
Part Number - 90000497 - A $\phi 160$ mm (M) (GSK) to B $\phi 200$ mm (F)
Part Number - 90000480 - A $\phi 180$ mm (M) (GSK) to B $\phi 160$ mm (F)
Part Number - 90000500 - A $\phi 180$ mm (M) (GSK) to B $\phi 200$ mm (F)

Key: (M) Male, (F) Female (GSK) Gasket with seal.

Metal Reducer Connector with Airtight Seal. (Female to male with seal)

Part Number - 9041163 - A $\phi 160$ mm (F) (GSK) to B $\phi 125$ mm (M)
Part Number - 90001346 - A $\phi 200$ mm (F) (GSK) to B $\phi 160$ mm (M)
Part Number - 90001279 - A $\phi 200$ mm (F) (GSK) to B $\phi 180$ mm (M)
Part Number - 90001280 - A $\phi 250$ mm (F) (GSK) to B $\phi 200$ mm (M)

Key: (M) Male, (F) Female (GSK) Gasket with seal.

Roof Terminal (Slate)

Part Number - 90001355 - $\phi 125$ mm
Part Number - 90001357 - $\phi 150$ mm
Part Number - 90001359 - $\phi 160$ mm
Part Number - 90001352 - $\phi 200$ mm

Roof terminal for supply and exhaust air.

Roof Terminal (Terracotta)

Part Number - 90001356 - $\phi 125$ mm
Part Number - 90001358 - $\phi 150$ mm
Part Number - 90001360 - $\phi 160$ mm
Part Number - 90001353 - $\phi 200$ mm

Roof terminal for supply and exhaust air.

Airslate & Adaptor

Part Number - 90000453
 $\phi 100/110/125/150/160$ - Slate

Universal Roof Terminal & Adaptor

Part Number - 90000349
 $\phi 100$ mm / 110 / 125 / 150 / 160 mm - Anthracite

Universal Roof Terminal & Adaptor

Part Number - 90000351
 $\phi 100$ mm / 110 / 125 / 150 / 160 mm - Terracotta

Universal Roof Terminal & Adaptor

Part Number - 90000350
 $\phi 100$ mm / 110 / 125 / 150 / 160 mm - Sepia

MULTIPLEXBOX DIMENSIONS



MultiPlexBox Pro Right

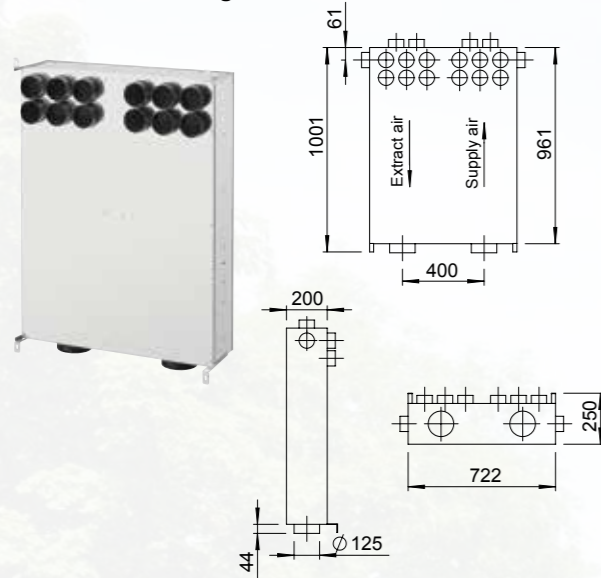

The standard 2x6 Supply and Extract AirflexPro connections are orientated 90 degrees to the main body. 1x extra port for supply and extract is located on the side of the unit. These are facilitated by knockout points. Compact design with easy installation and maintenance. Please see above image for the individual dimensions. The supply air to the dwelling is on the right hand side in this unit as you look at the unit.

MultiPlexBox Pro Left

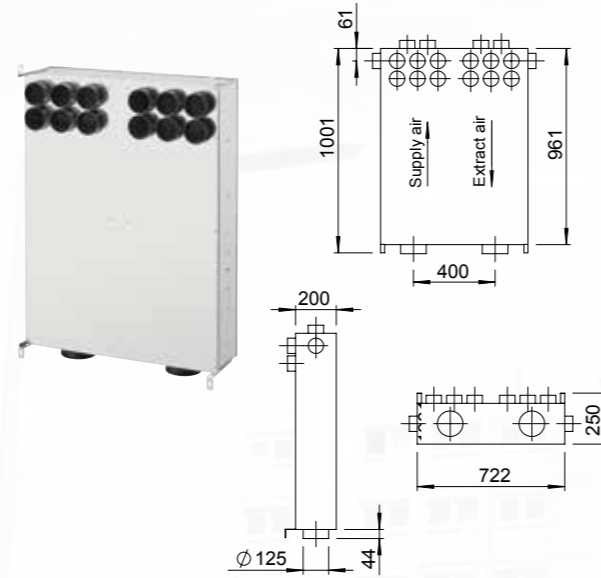

The standard 2x6 Supply and Extract AirflexPro connections are orientated 90 degrees to the main body. 1x extra port for supply and extract is located on the side of the unit. These are facilitated by knockout points. Compact design with easy installation and maintenance. Please see above image for the individual dimensions. The supply air to the dwelling is on the left hand side in this unit as you look at the unit.

MultiPlexBox Pro Straight-through

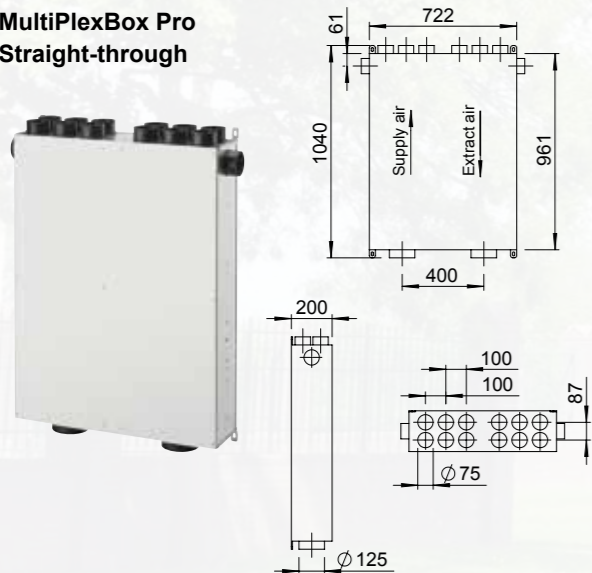

The standard 2x6 sets of Supply and Extract AirflexPro connections are orientated to give straight through duct connections. 1x extra port for supply and extract is located on the side of the unit. These are facilitated by knockout points. Compact design with easy installation and maintenance. Please see above image for the individual dimensions. Unit supplied with two inspection covers, one on each side enabling the unit to be left or right handed.

MultiPlexBox 125mm Straight-through

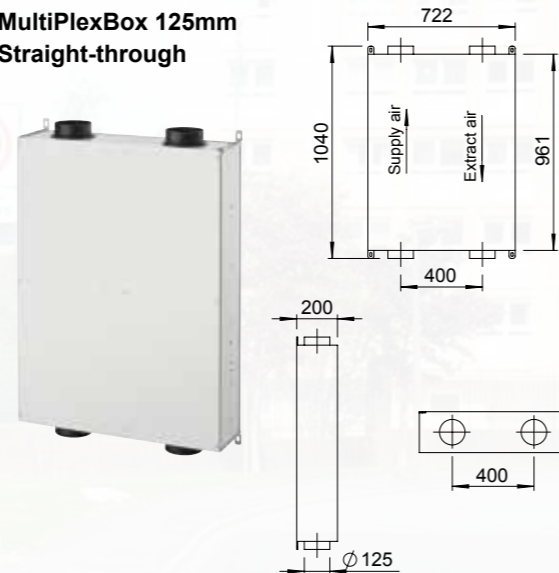

Standard 4x 125mm Ports are placed at the top and bottom of the item to give straight through duct connections. Compact design with easy installation and maintenance. Please see above image for the individual dimensions. Unit supplied with two inspection covers, one on each side enabling the unit to be left or right handed.

FIELD SUPPORT



FIELD SUPPORT



At Airflow we do not view any of our customers a short term agreement. We believe that by working together in partnership we can achieve better results in realising our shared objectives to deliver efficient, effective and reliable ventilation solutions.

Our knowledgeable, trained technicians can provide support to ensure your ventilation project runs smoothly and where issues arise, they can advise on the most suitable course of action to provide a successful outcome.

Airflow offers full field support across the UK and are supported by an internal technical team offering help and support for any issues or queries.



CONTACT US



Airflow Developments Limited

Tel: 01494 525252
e-mail: info@airflow.com

Customer Services

Tel: 01494 560800
e-mail: customer_services@airflow.com

Technical Support

Tel: 01494 560950
e-mail: technical_support@airflow.com

Airflow Developments Limited

Aidelle House, Lancaster Road,
Cressex Business Park,
High Wycombe, Buckinghamshire,
United Kingdom, HP12 3QP

Registered company 550374

airflow.com

Also Available Through



Connect With Us!

- AirflowD
- AirflowDevelopments1
- AirflowD
- airflowdevelopmentsltd
- Airflow Developments
- Airflow Developments



UNITED KINGDOM (head office)

Airflow Developments Limited
Aidelle House, Lancaster Road
Cressex Business Park
High Wycombe, Bucks. HP12 3QP.

Tel: +44 (0) 1494 525252
Email: info@airflow.com
Web: airflow.com

GERMANY

Airflow Lufttechnik GmbH
Wolbersacker 16
53359
Rheinbach, Germany

Tel: +49 (0) 2226 92050
Email: info@airflow.de
Web: airflow.de

CZECH REPUBLIC

Airflow Lufttechnik - Praha
Hostynska 520
10800 Praha 10
Prague, Czech Republic

Tel: +42 (0) 2747 72230
Email: info@airflow.cz
Web: airflow.cz